

不锈钢平顶链
STAINLESS STEEL FLAT TOP CHAINS

塑料平顶链
PLASTIC FLAT TOP CHAINS

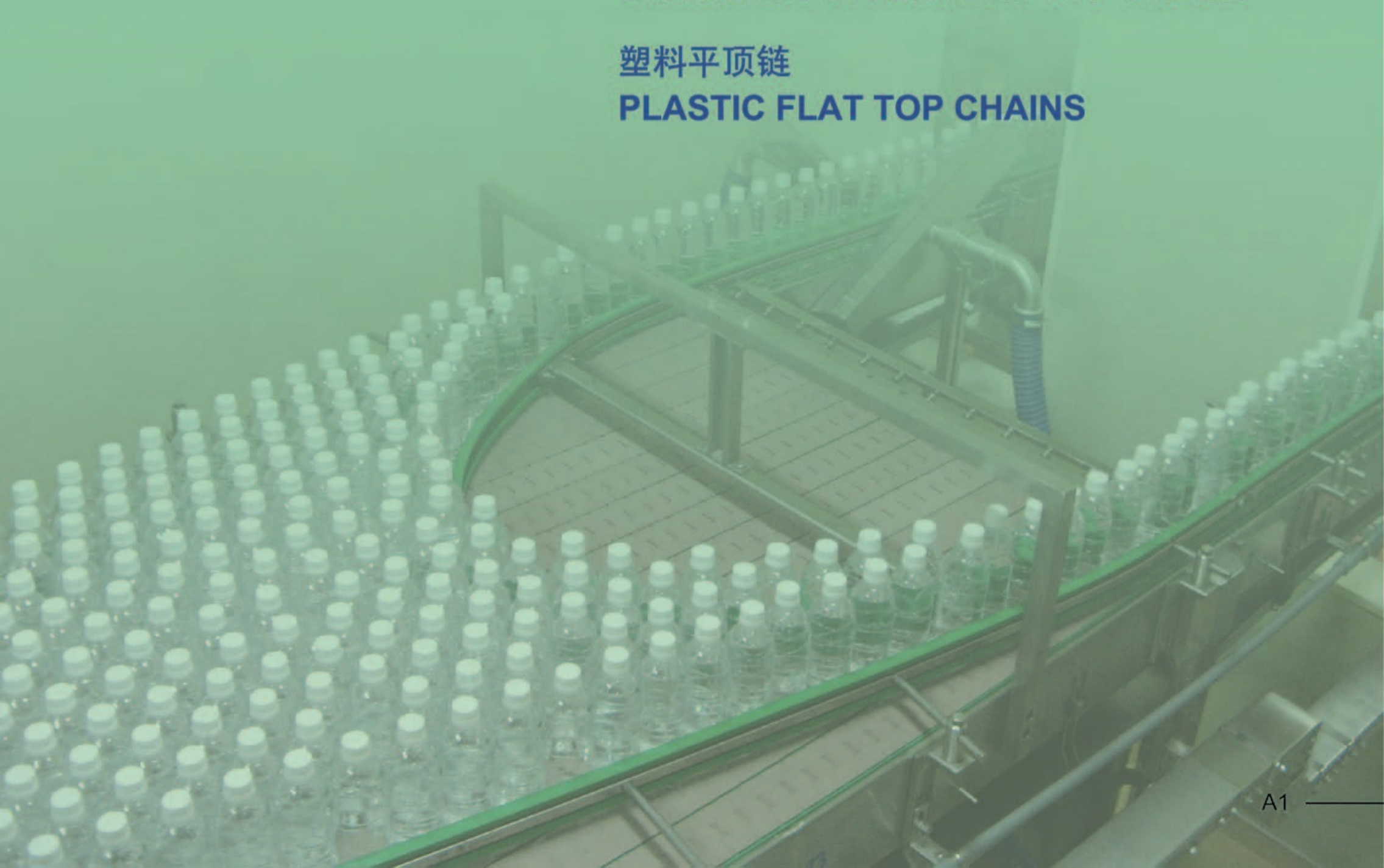

不锈钢平顶链 *Stainless Steel Flat Top Chains*

SS812/815 单铰直输平顶链 SS812/815 SINGLE HINGE STRAIGHT RUNNING

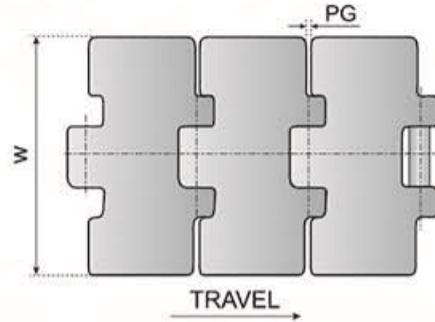
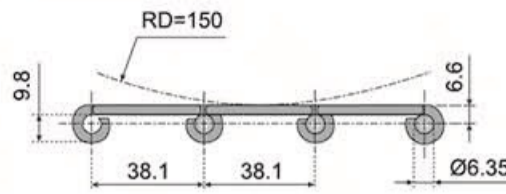
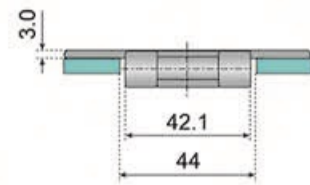
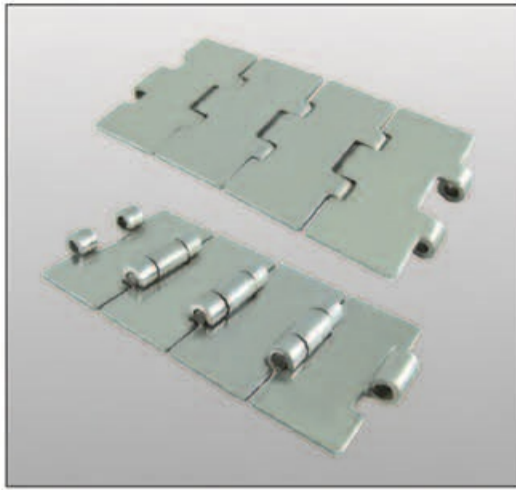

链号 Chain No.	宽度 Width (W)		重量 Weight		链板间隙 Plate Gap (PG)
	mm	inch	kg/m	lbs/ft	mm
SS812/815 - K205	53	2.05	2.1	1.42	1.8
SS812/815 - K250	63.5	2.50	2.3	1.55	1.8
SS812/815 - K263	66.8	2.63	2.4	1.62	1.8
SS812/815 - K300	76.2	3.00	2.5	1.68	1.8
SS812/815 - K325	82.6	3.25	2.6	1.75	1.8
SS812/815 - K350	88.9	3.50	2.7	1.81	1.8
SS812/815 - K400	101.6	4.00	3.2	2.15	1.8
SS812/815 - K450	114.3	4.50	3.5	2.35	1.8
SS812/815 - K500	127	5.00	3.6	2.42	1.8
SS812/815 - K600	152.4	6.00	4.4	2.96	1.8
SS812/815 - K750	190.5	7.50	5.3	3.56	1.8

- 主要适用于各种玻璃瓶以及重负载金属类输送线，最适合啤酒制造业。
- 建议使用润滑剂。
- 最大输送长度为15米。
- 最高速度：润滑剂 90米/分钟
干燥 60米/分钟
- 工作载荷：2600N
- 材质：
奥氏体不锈钢 SS301/SS304 (无磁性的)
铁素体不锈钢 SS420/SS430 (有磁性的)
- 包装：10英尺 = 3.048 米/盒
1米 = 26片
- Widely used in all kinds of conveyor of bottle and heavy load such as metal.
- Especially applied to beer industry.
- Suggestion: lubricant
- The longest distance: 15M
- Max. speed: lubricant 90M/min
dryness 60M/min
- Working load: 2600N
- Material:
austenitic stainless steel (non-magnetic)
ferritic stainless steel (magnetic)
- Packing: 10 feet = 3.048 M/box 26pcs/M

SS802/805 双铰直输平顶链 SS802/805 DOUBLE HINGE STRAIGHT RUNNING

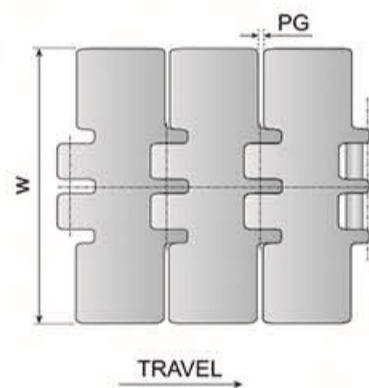
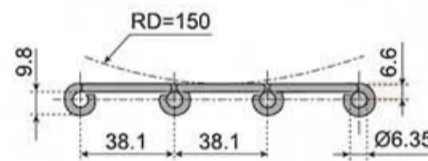
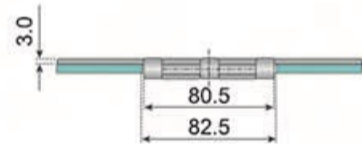
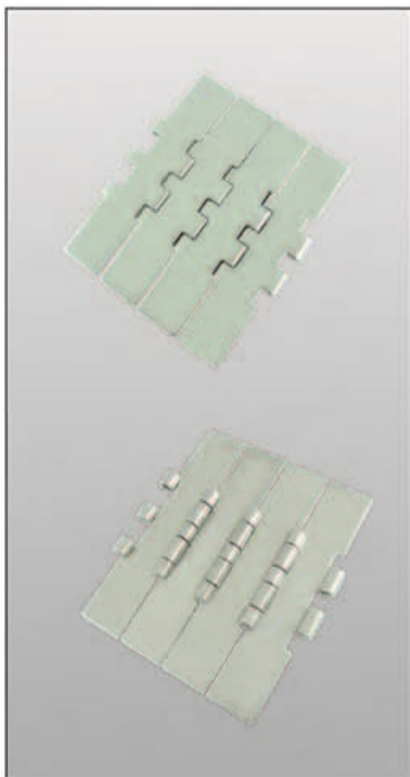

链号 Chain No.	宽度 Width (W)		重量 Weight		链板间隙 Plate Gap (PG)
	mm	inch	kg/m	lbs/ft	mm
SS802/805 - K750	190.5	7.50	5.9	3.97	1.8
SS802/805 - K1000	254	10	7.2	4.8	1.8
SS802/805 - K1200	304.8	12	8.3	5.6	1.8

- 主要适用于各种玻璃瓶以及重负载金属类输送线，最适合啤酒制造业。
- 建议使用润滑剂。
- 最大输送长度为15米。
- 最高速度：润滑剂 90米/分钟
干燥 60米/分钟
- 工作载荷：5200N
- 材质：
奥氏体不锈钢 SS301/SS304 (无磁性的)
铁素体不锈钢 SS420/SS430 (有磁性的)
- 包装：10英尺 = 3.048 米/盒
1米 = 26片
- Widely used in all kinds of conveyor of bottle and heavy load such as metal.
- Especially applied to beer industry.
- Suggestion: lubricant
- The longest distance: 15M
- Max. speed: lubricant 90M/min
dryness 60M/min
- Working load: 5200N
- Material:
austenitic stainless steel (non-magnetic)
ferritic stainless steel (magnetic)
- Packing: 10 feet = 3.048 M/box 26pcs/M

不锈钢平顶链 *Stainless Steel Flat Top Chains*

SS512/515 小节距单铰直输平顶链 SS512/515 SINGLE HINGE – Pitch 25.4 mm (1") STRAIGHT RUNNING

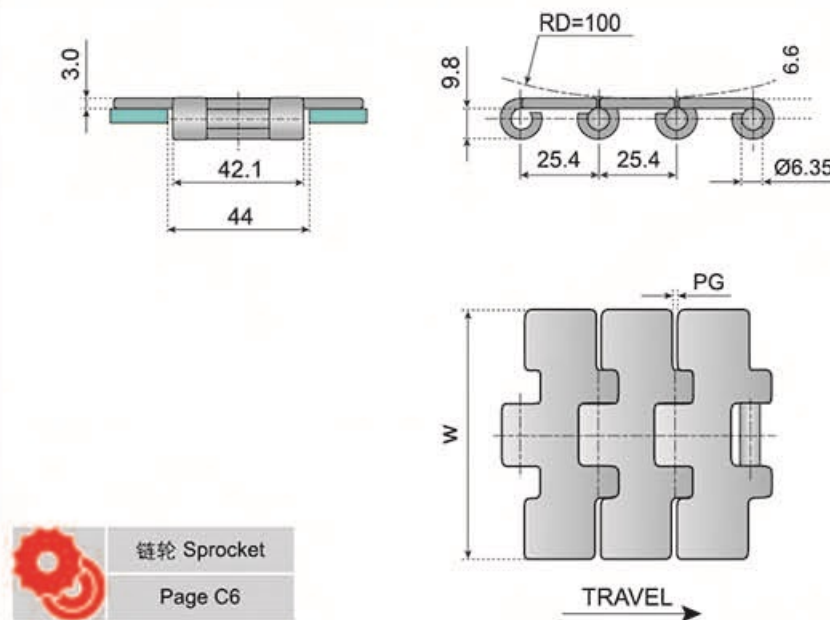
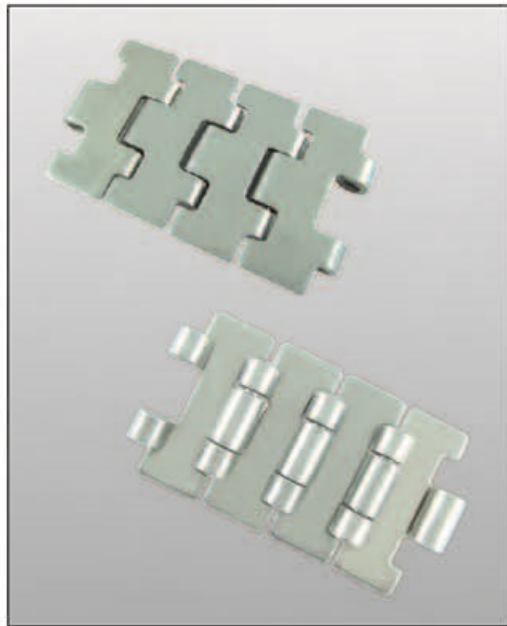

链轮 Sprocket
Page C6

- 主要适用于各种玻璃瓶以及重负载金属类输送线，最适合啤酒制造业。
- 建议使用润滑剂。
- 最大输送长度为15米。
- 最高速度：润滑剂 90米/分钟
干燥 60米/分钟
- 工作载荷：2600N
- 材质：
奥氏体不锈钢 SS301/SS304 (无磁性的)
铁素体不锈钢 SS420/SS430 (有磁性的)
- 包装：10英尺 = 3.048 米/盒
1米 = 39片
- Widely used in all kinds of conveyor of bottle and heavy load such as metal.
- Especially applied to beer industry.
- Suggestion: lubricant
- The longest distance: 15M
- Max. speed: lubricant 90M/min
dryness 60M/min
- Working load: 2600N
- Material:
austenitic stainless steel (non-magnetic)
ferritic stainless steel (magnetic)
- Packing: 10 feet = 3.048 M/box 39pcs/M

链号 Chain No.	宽度 Width (W)		重量 Weight		链板间隙 Plate Gap (PG)
	mm	inch	kg/m	lbs/ft	mm
SS512/515 - K217	55	2.17	2.1	1.42	1.6
SS512/515 - K250	63.5	2.50	2.3	1.55	1.6
SS512/515 - K283	72	2.83	2.4	1.62	1.6
SS512/515 - K325	82.6	3.25	2.5	1.68	1.6
SS512/515 - K350	88.9	3.50	2.6	1.75	1.6
SS512/515 - K385	98	3.85	2.7	1.81	1.6
SS512/515 - K400	101.6	4.00	3.2	2.15	1.6

SS812/815 MINI型单铰直输平顶链 SS812/815 MINI SINGLE HINGE STRAIGHT RUNNING

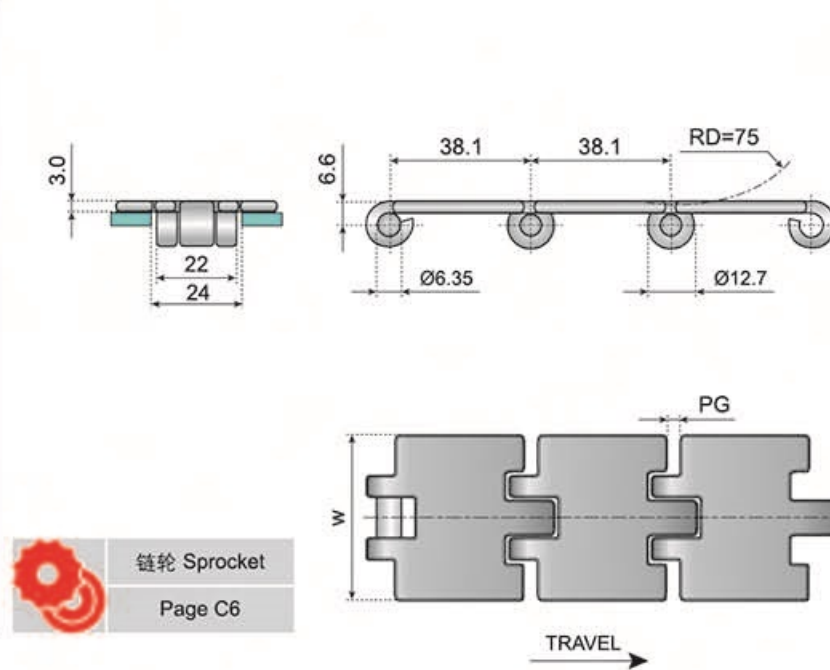
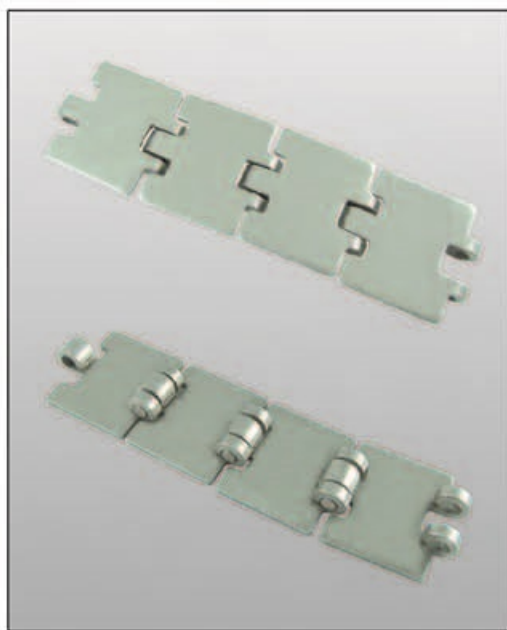

链轮 Sprocket
Page C6

- 主要适用于各种玻璃瓶以及重负载金属类输送线。
- 建议使用润滑剂。
- 最大输送长度为15米。
- 最高速度：润滑剂 90米/分钟
干燥 60米/分钟
- 工作载荷：1300N
- 材质：
奥氏体不锈钢 SS301/SS304 (无磁性的)
铁素体不锈钢 SS420/SS430 (有磁性的)
- 包装：10英尺 = 3.048 米/盒
1米 = 26片
- Widely used in all kinds of conveyor of bottle and heavy load such as metal.
- Suggestion: lubricant
- The longest distance: 15M
- Max. speed: lubricant 90M/min
dryness 60M/min
- Working load: 1300N
- Material:
austenitic stainless steel (non-magnetic)
ferritic stainless steel (magnetic)
- Packing: 10 feet = 3.048 M/box 26pcs/M

链号 Chain No.	宽度 Width (W)		重量 Weight		链板间隙 Plate Gap (PG)
	mm	inch	kg/m	lbs/ft	mm
SS812/815 mini - K125	32	1.25	1.2	0.81	1.8
SS812/815 mini - K175	45	1.75	1.6	1.08	1.8

不锈钢平顶链 *Stainless Steel Flat Top Chains*

SS8157 重载单铰直输平顶链 SS8157 HEAVY DUTY SINGLE HINGE STRAIGHT RUNNING

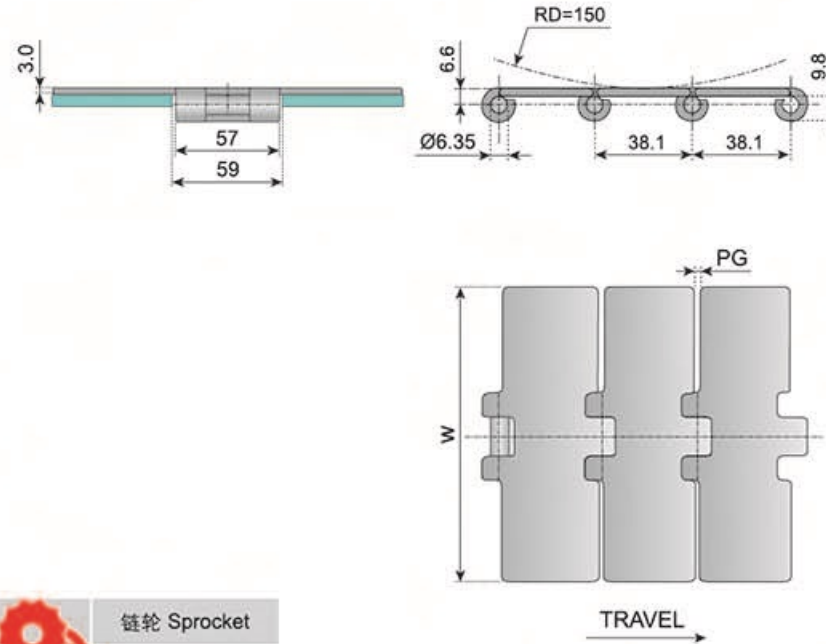

链号 Chain No.	宽度 Width (W)		重量 Weight		链板间隙 Plate Gap (PG) mm
	mm	inch	kg/m	lbs/ft	
SS8157 - K750	190.5	7.50	5.6	3.77	1.8

- 主要适用于各种玻璃瓶以及重负载金属类输送线，最适合啤酒制造业。
- 建议使用润滑剂。
- 最大输送长度为15米。
- 最高速度：润滑剂 90米/分钟
干燥 60米/分钟
- 工作载荷：5200N
- 材质：
奥氏体不锈钢 SS301/SS304 (无磁性的)
铁素体不锈钢 SS420/SS430 (有磁性的)
- 包装：10英尺 = 3.048 米/盒
1米 = 26片
- Widely used in all kinds of conveyor of bottle and heavy load such as metal.
- Especially applied to beer industry.
- Suggestion: lubricant
- The longest distance: 15M
- Max. speed: lubricant 90M/min
dryness 60M/min
- Working load: 5200N
- Material:
austenitic stainless steel (non-magnetic)
ferritic stainless steel (magnetic)
- Packing: 10 feet = 3.048 M/box 26pcs/M

SS8857M 无导型重载磁性转弯平顶链 SS8857M MAGNETIC HEAVY DUTY SIDEFLEXING

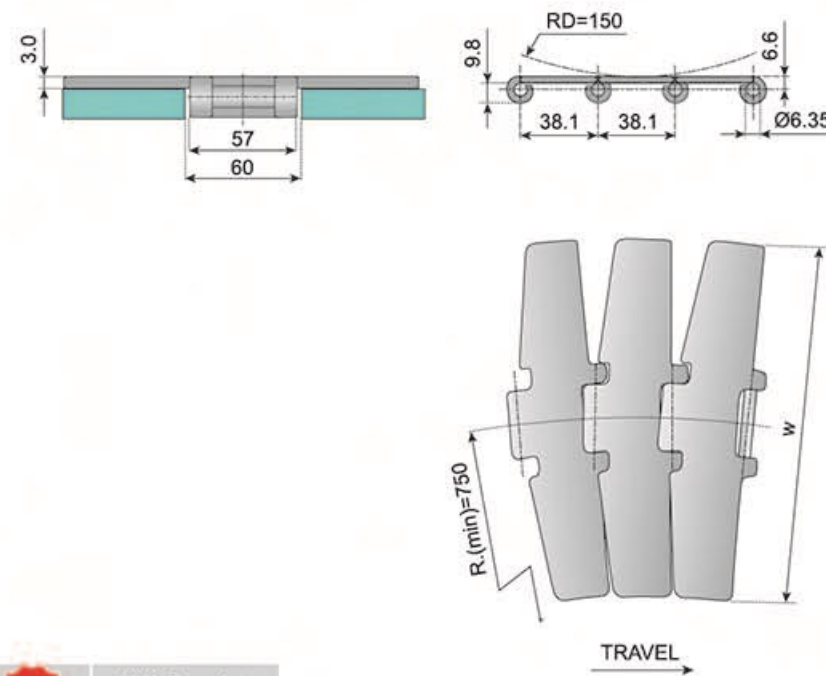
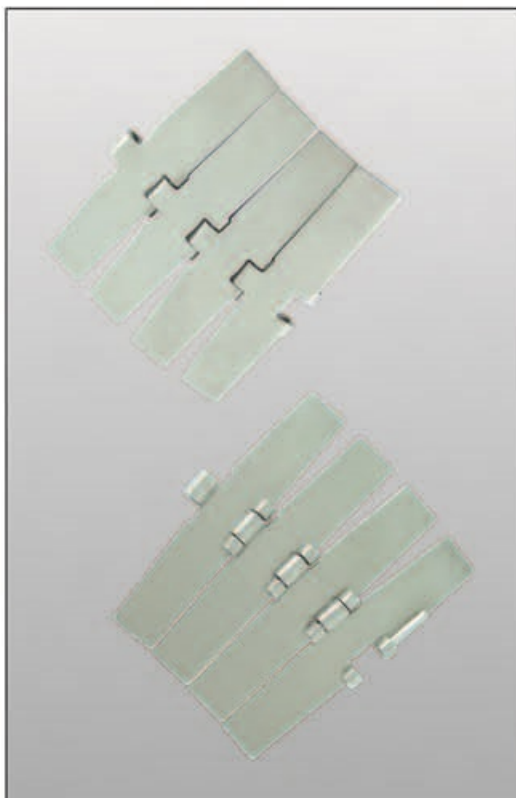

链号 Chain No.	宽度 Width (W)		重量 Weight	
	mm	inch	kg/m	lbs/ft
SS8857M - K750	190.5	7.50	5.3	3.56

- 主要适用于各种玻璃瓶以及重负载金属类输送线，最适合啤酒制造业。
- 可选用弯导轨或转盘来转弯运输。
- 建议使用润滑剂。
- 最大输送长度为12米。
工作载荷：4500N
- 材质：铁素体不锈钢 SS420/SS430 (有磁性的)
- 包装：10英尺 = 3.048 米/盒
1米 = 26片
- Widely used in all kinds of conveyor of bottle and heavy load such as metal.
- Especially applied to beer industry.
- Corner tracks or turning disks can be selected for curved transportation.
- Suggestion: lubricant
- The longest distance: 12M
- Working load: 4500N
- Material:
ferritic stainless steel (magnetic)
- Packing: 10 feet = 3.048 M/box 26pcs/M



不锈钢平顶链 *Stainless Steel Flat Top Chains*

SS881TAB 有翼型转弯平顶链 SS881TAB SIDEFLEXING

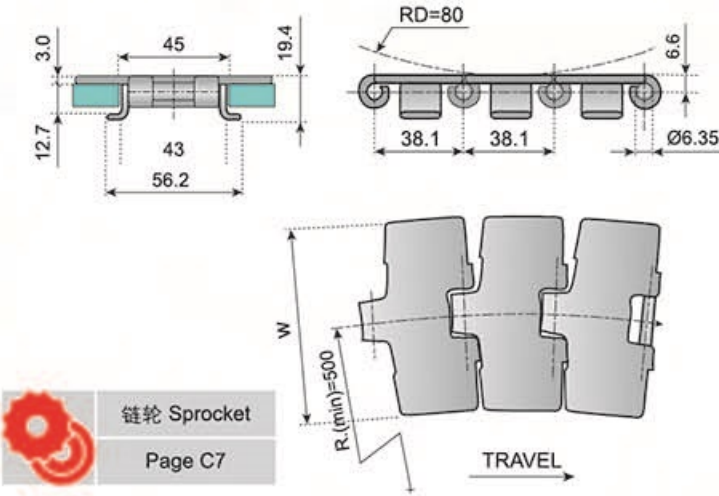
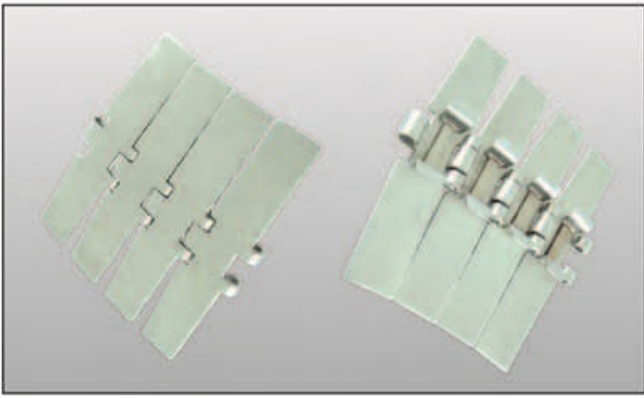

链轮 Sprocket
Page C7

- 主要适用于各种玻璃瓶以及重负载金属类输送线，最适合啤酒制造业。
- 可选用弯导轨或转盘来转弯运输。
- 建议使用润滑剂。
- 最大输送长度为12米。
- 工作载荷：2250N
- 材质：
奥氏体不锈钢 SS301/SS304 (无磁性的)
- 包装：10英尺 = 3.048 米/盒

链号 Chain No.	宽度 Width (W)		重量 Weight	
	mm	inch	kg/m	lbs/ft
SS881TAB - K325	82.6	3.25	3.1	2.09
SS881TAB - K450	114.3	4.50	3.6	2.42
SS881TAB - K600	152.4	6.00	4.6	3.09
SS881TAB - K750	190.5	7.50	5.3	3.56
SS881TAB - K1000	254	10	8	5.36
SS881TAB - K1200	304.8	12	9	6.04

- 1米 = 26片
- Widely used in all kinds of conveyor of bottle and heavy load such as metal.
- Especially applied to beer industry.
- Corner tracks or turning disks can be selected for curved transportation.
- Suggestion: lubricant
- The longest distance: 12M
- Working load: 2250N
- Material:
austenitic stainless steel (non-magnetic)
- Packing: 10 feet = 3.048 M/box 26pcs/M



SS881 燕尾八字型转弯平顶链 SS881 BEVEL SIDEFLEXING

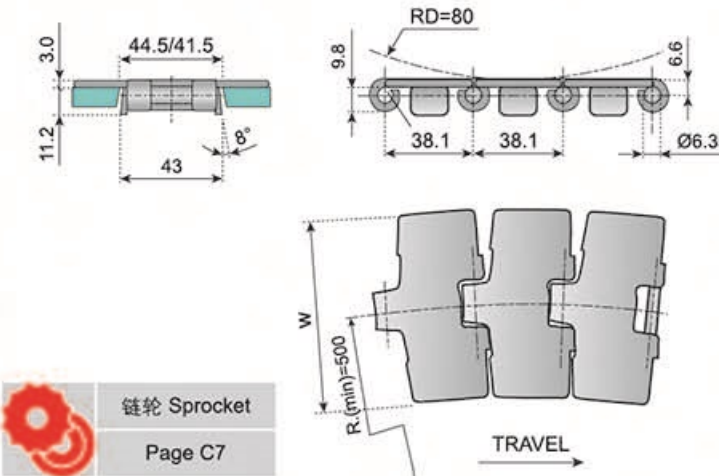
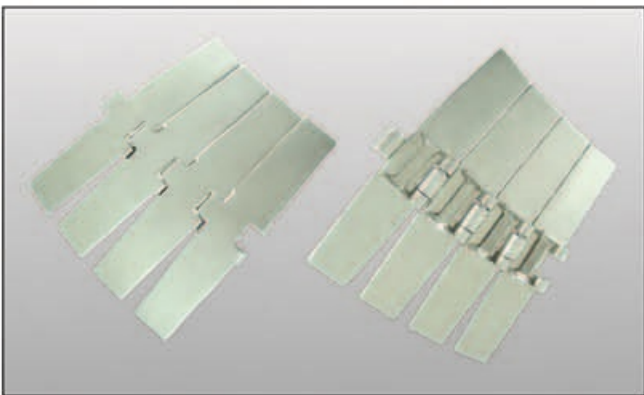

链轮 Sprocket
Page C7

链号 Chain No.	宽度 Width (W)		重量 Weight	
	mm	inch	kg/m	lbs/ft
SS881 - K325	82.6	3.25	2.9	1.95
SS881 - K450	114.3	4.50	3.8	2.56
SS881 - K600	152.4	6.00	4.3	2.89
SS881 - K750	190.5	7.50	5.1	3.43

- 主要适用于各种玻璃瓶以及重负载金属类输送线，最适合啤酒制造业。
- 可选用弯导轨或转盘来转弯运输。
- 建议使用润滑剂。
- 最大输送长度为12米。
- 工作载荷：2250N
- 材质：
铁素体不锈钢 SS420/SS430 (有磁性的)
- 包装：10英尺 = 3.048 米/盒
- 1米 = 26片
- Widely used in all kinds of conveyor of bottle and heavy load such as metal.
- Especially applied to beer industry.
- Corner tracks or turning disks can be selected for curved transportation.
- Suggestion: lubricant
- The longest distance: 12M
- Working load: 2250N
- Material:
ferritic stainless steel (magnetic)
- Packing: 10 feet = 3.048 M/box 26pcs/M

SS881M 无导型磁性转弯平顶链 SS881M MAGNETIC SIDEFLEXING

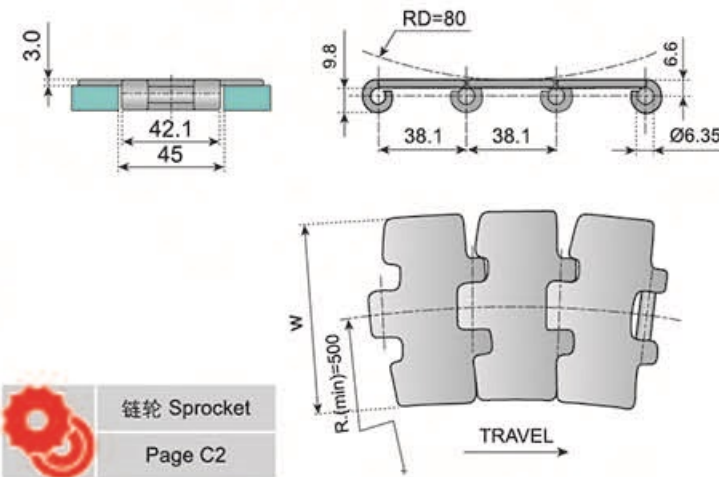
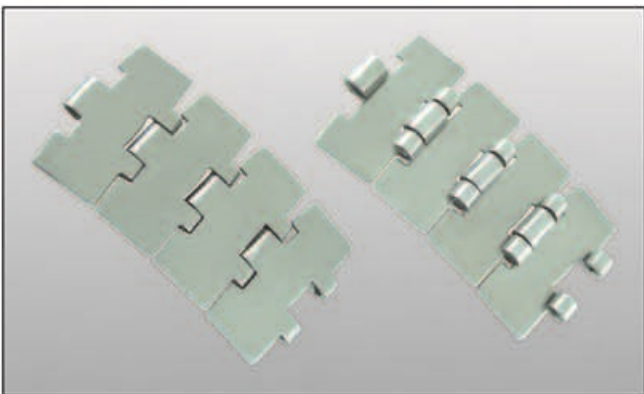

链轮 Sprocket
Page C2

链号 Chain No.	宽度 Width (W)		重量 Weight	
	mm	inch	kg/m	lbs/ft
SS881M - K325	82.6	3.25	2.6	1.75
SS881M - K450	114.3	4.50	3.5	2.35
SS881M - K600	152.4	6.00	4.1	2.75
SS881M - K750	190.5	7.50	4.9	3.30

顶板链 Plate Top Chains

1864 直行顶板链, 基链节距19.05mm (3/4")
1864 Plate Top Chains, Straight Running, 19.05MM (3/4") Pitch

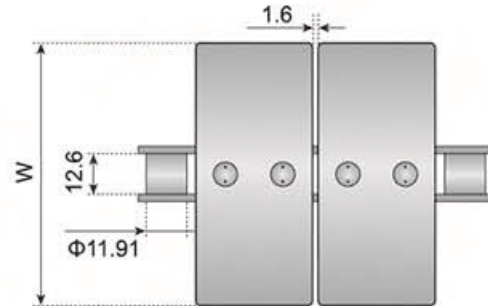
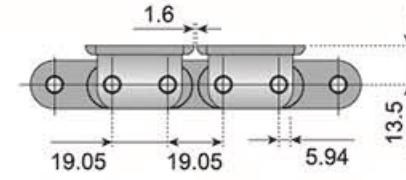
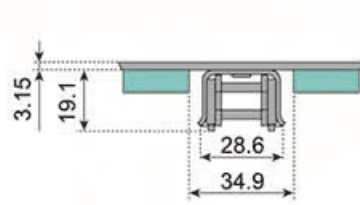

 链轮 Sprocket
Page C21/C22

链号 Chain No.	宽度 Width (W)		重量 Weight		载荷 Working load
	mm	inch	kg/m	lbs/ft	N
STEEL TOP PLATE / STEEL BASE CHAIN					
1864 - K325	82.5	3.25	3.33	2.24	4500
1864 - K450	114.3	4.50	4.00	2.69	4500
1864 - K600	152.4	6.00	4.40	2.95	4500
1864 - K750	190.5	7.50	4.80	3.22	4500
STAINLESS STEEL TOP PLATE / STAINLESS STEEL BASE CHAIN					
1864 SS- K325	82.5	3.25	3.33	2.24	3400
1864 SS - K450	114.3	4.50	4.00	2.69	3400
1864 SS - K600	152.4	6.00	4.40	2.95	3400
1864 SS - K750	190.5	7.50	4.80	3.22	3400

1874TAB 转弯顶板链, 基链节距19.05mm (3/4")
1874TAB Plate Top Chains, Sideflexing, 19.05MM (3/4") Pitch

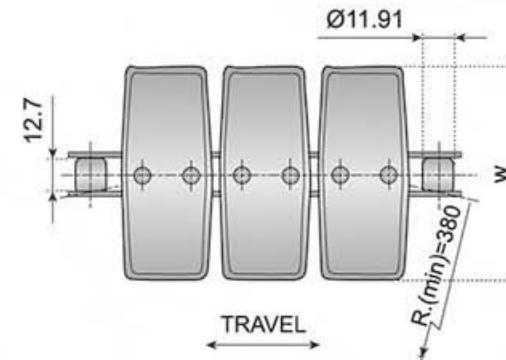
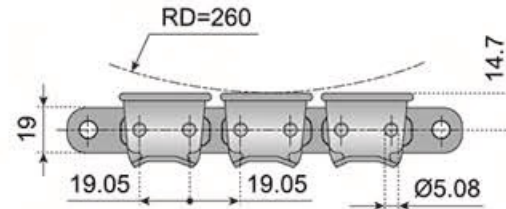
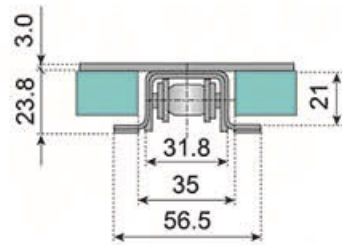

 链轮 Sprocket
Page C21/C22

链号 Chain No.	宽度 Width (W)		重量 Weight		载荷 Working load
	mm	inch	kg/m	lbs/ft	N
STEEL TOP PLATE / STEEL BASE CHAIN					
1874 TAB - K325	82.5	3.25	3.33	2.24	4500
1874 TAB - K450	114.3	4.50	4.00	2.69	4500
1874 TAB - K600	152.4	6.00	4.40	2.95	4500
1874 TAB - K750	190.5	7.50	4.80	3.22	4500
STAINLESS STEEL TOP PLATE / STAINLESS STEEL BASE CHAIN					
1874 TAB SS- K325	82.5	3.25	3.33	2.24	3400
1874 TAB SS - K450	114.3	4.50	4.00	2.69	3400
1874 TAB SS - K600	152.4	6.00	4.40	2.95	3400
1874 TAB SS - K750	190.5	7.50	4.80	3.22	3400

扣链式提升链/顶板链 Flat Top Chains / Welded Flat Top Chains

1874TAB-G 扣链式提升链 1874TAB-G Sideflexing with Snap on Gripper

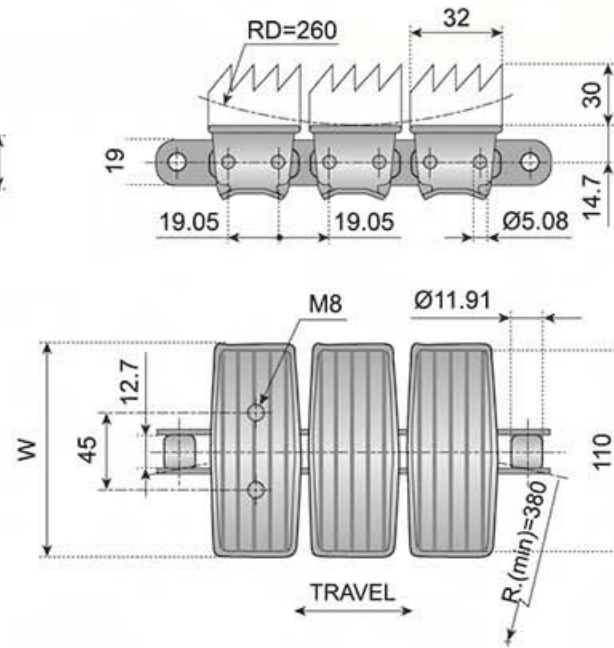
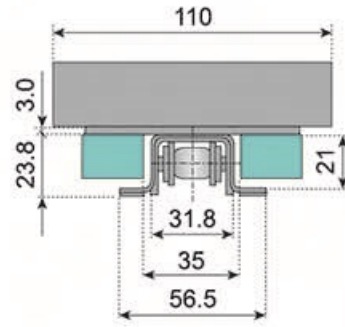
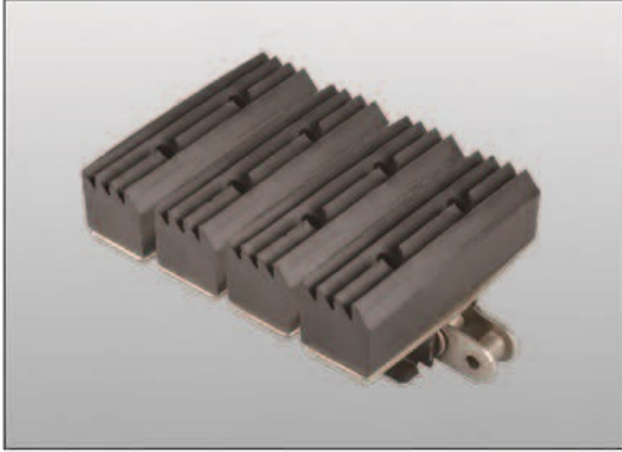

链轮 Sprocket
Page C21/C22

链号 Chain No.	宽度 Width (W)		重量 Weight		载荷 Working load N
	mm	inch	kg/m	lbs/ft	
STEEL TOP PLATE / STEEL BASE CHAIN					
1874 TAB - K325G	82.6	3.25	3.33	2.24	4500
1874 TAB - K450G	114.3	4.50	4.00	2.69	4500
1874 TAB - K600G	152.4	6.00	4.40	2.95	4500
1874 TAB - K750GG	190.5	7.50	4.80	3.22	4500
STAINLESS STEEL TOP PLATE / STAINLESS STEEL BASE CHAIN					
1874 TAB SS - K325G	82.6	3.25	3.33	2.24	3400
1874 TAB SS - K450G	114.3	4.50	4.00	2.69	3400
1874 TAB SS - K600G	152.4	6.00	4.40	2.95	3400
1874 TAB SS - K750G	190.5	7.50	4.80	3.22	3400

TPW 焊接顶板链 TPW Welded Plate Top Chains

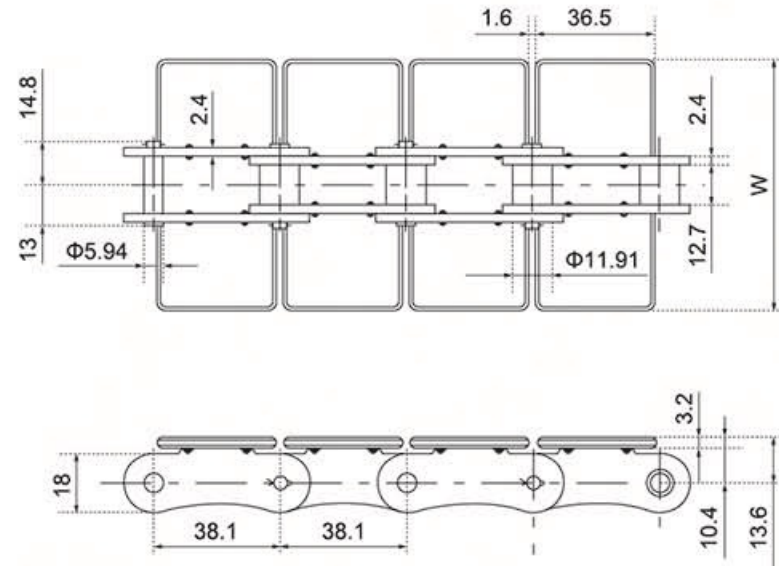

材质: 碳钢或不锈钢
Material: Carbon Steel or Stainless Steel

链号 Chain No.	宽度 Width (W)		重量 Weight	
	mm	inch	kg/m	lbs/ft
TPW - K217	55	2.17	2.7	1.82
TPW - K250	63.5	2.50	2.9	1.95
TPW - K300	76.2	3.00	3.2	2.15
TPW - K325	82.6	3.25	3.3	2.22
TPW - K375	95.3	3.75	3.6	2.42
TPW - K400	101.6	4.00	3.8	2.56
TPW - K450	114.3	4.50	4.0	2.69
TPW - K500	127	5.00	4.3	2.89
TPW - K600	152.4	6.00	5.0	3.36
TPW - K750	190.5	7.50	5.9	3.97

不锈钢平顶链(顶部带防滑胶) *Stainless Steel Chains With Rubber Top*

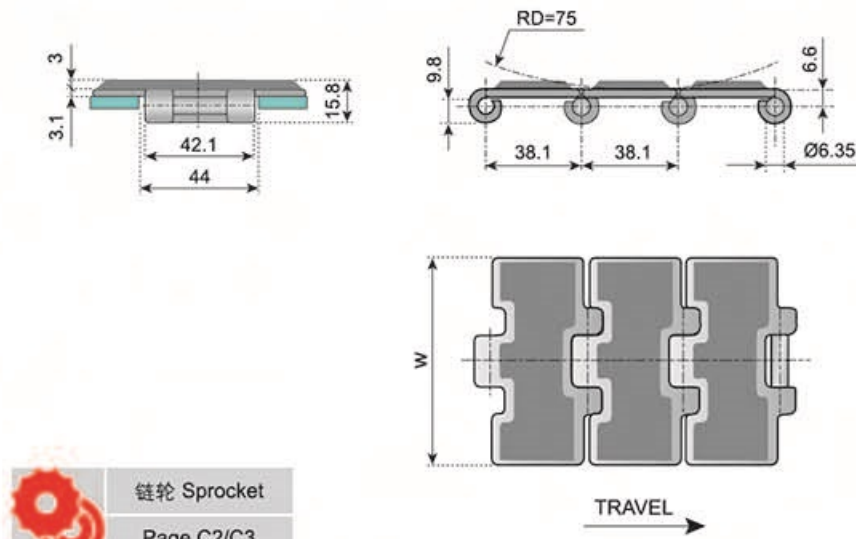
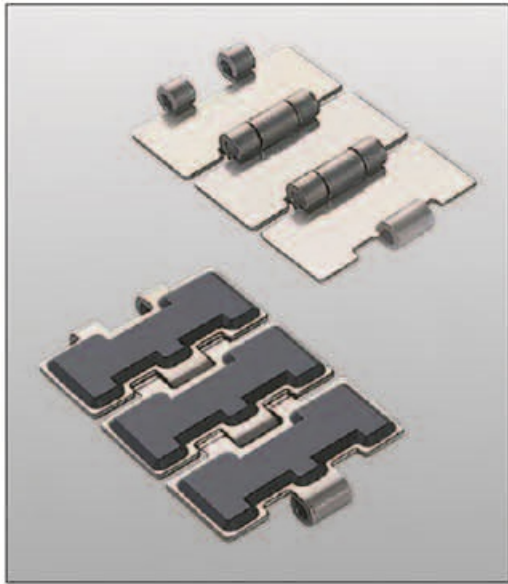

链轮 Sprocket
Page C2/C3

SS812/815G 防滑单铰直输平顶链
SS812/815G WITH RUBBER TOP

链号 Chain No.	宽度 Width (W)	
	mm	inch
SS812/815 - K325G	82.6	3.25
SS812/815 - K450G	114.3	4.50
SS812/815 - K750G	190.5	7.50

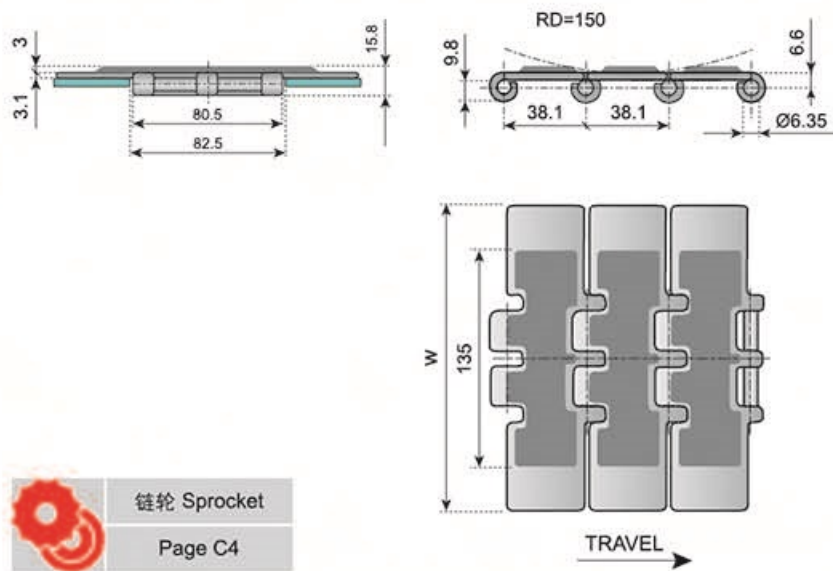
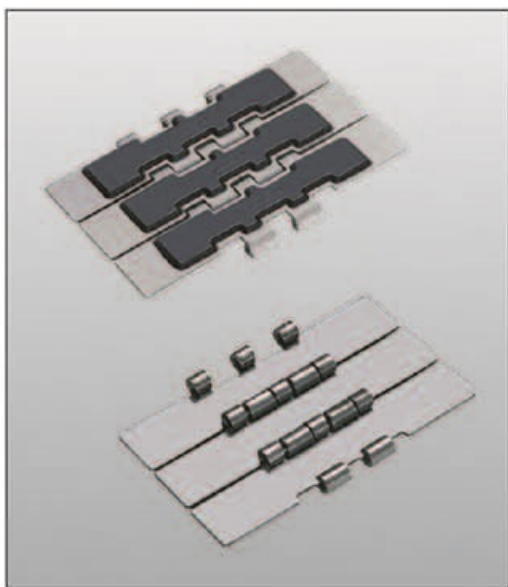

链轮 Sprocket
Page C4

SS802/805G 防滑双铰直输平顶链
SS802/805G WITH RUBBER TOP

链号 Chain No.	宽度 Width (W)	
	mm	inch
SS802/805 - K750G	190.5	7.50
SS802/805 - K1000G	254	10.00
SS802/805 - K1200G	304.8	12.00

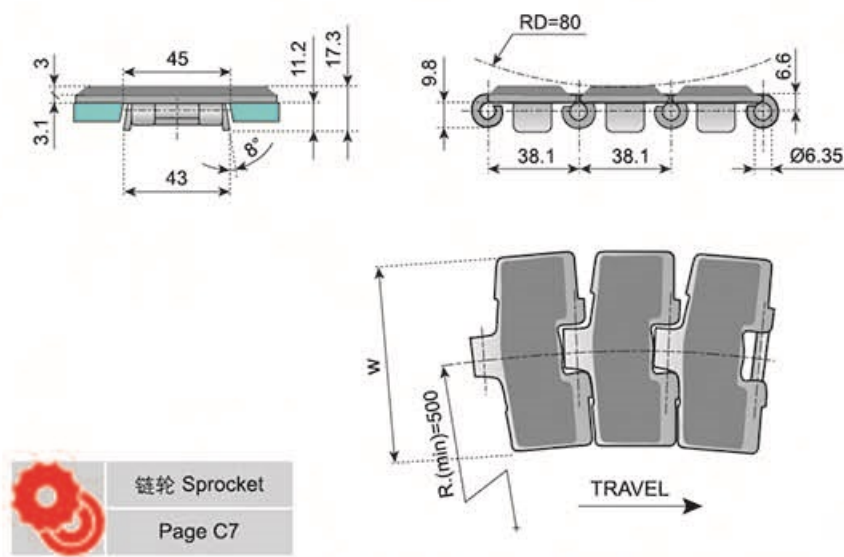

链轮 Sprocket
Page C7

SS881G 防滑侧弯平顶链
SS881G WITH RUBBER TOP

链号 Chain No.	宽度 Width (W)	
	mm	inch
SS881 - K325G	82.6	3.25
SS881 - K450G	114.3	4.50
SS881 - K600G	152.4	6.00
SS881 - K750G	190.5	7.50

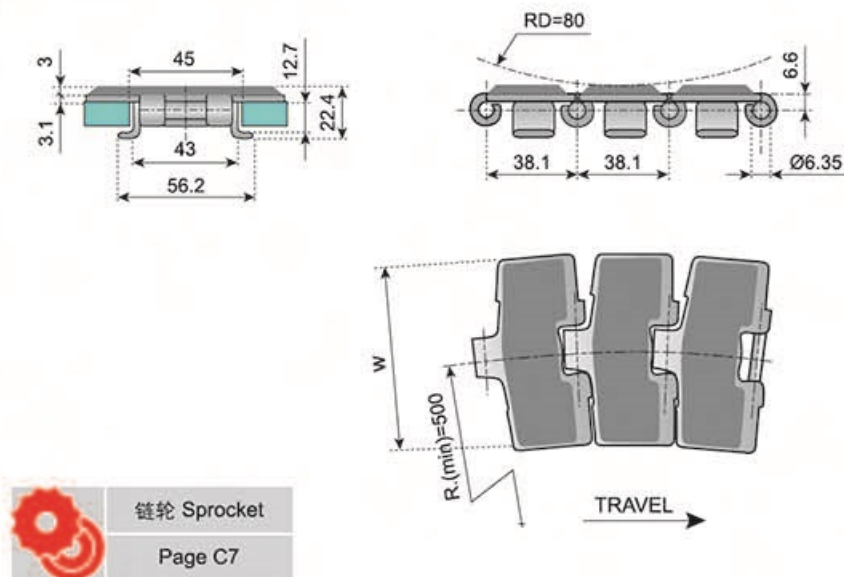

链轮 Sprocket
Page C7

SS881TAB-G 防滑侧弯平顶链
SS881TAB-G WITH RUBBER TOP

链号 Chain No.	宽度 Width (W)	
	mm	inch
SS881TAB - K325G	82.6	3.25
SS881TAB - K450G	114.3	4.50
SS881TAB - K600G	152.4	6.00
SS881TAB - K750G	190.5	7.50
SS881TAB - K1000G	254	10.0
SS881TAB - K1200G	304.8	12.00

塑料平顶链 Plastic Flat Top Chains

LF810TAB 系列转弯链 LF 810TAB SERIES CHAIN SIDEFLEXING

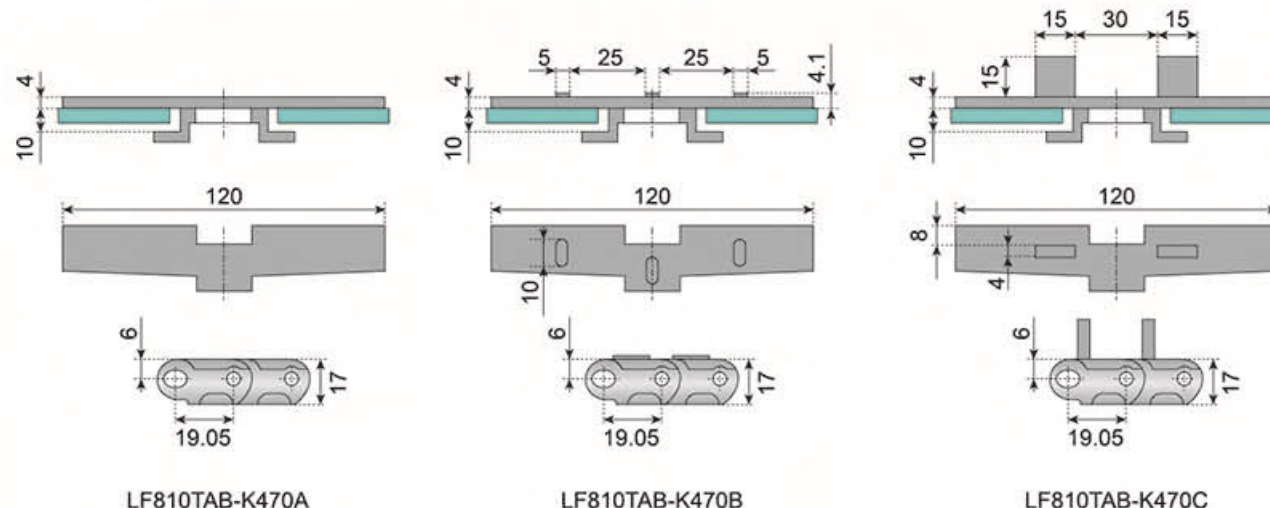
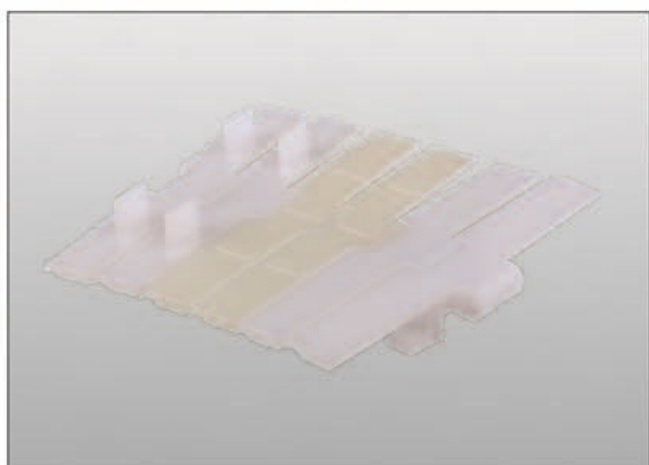

链号 Chain No.	宽度 Width (W)		重量 Weight		最小侧弯半径 Minimum Radius R min. (mm)
	mm	inch	kg/m	lbs/ft	
LF810TAB-K470A	120	4.7	0.78	0.53	550
LF810TAB-K470B	120	4.7	0.80	0.58	550
LF810TAB-K470C	120	4.7	1.00	0.68	550

- 主要适用于方便面的输送。
- 最大输送长度为12米。
- 包装：10英尺 = 3.048 米/盒
1米=52片
- Mainly used for the conveyor of instant noodles.
- The longest distance: 12M
- Packing: 10 feet = 3.048 M/box 52pcs/M

LF810 单绞直输链 LF 810 CHAIN SINGLE HINGE STRAIGHT RUNNING

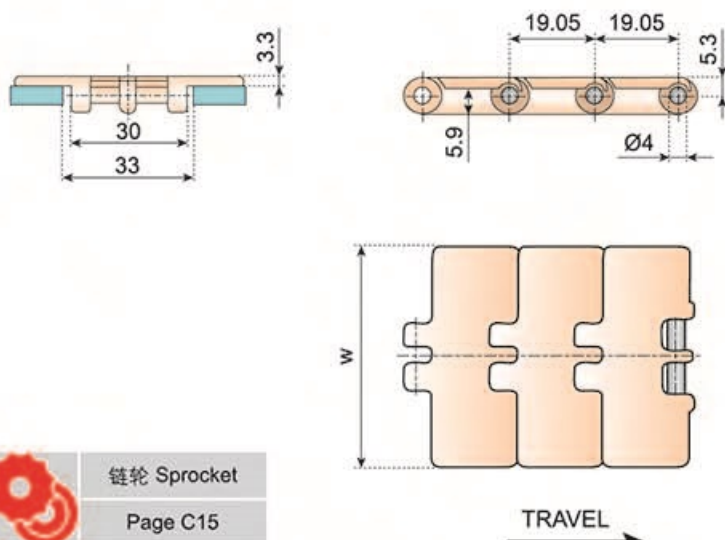
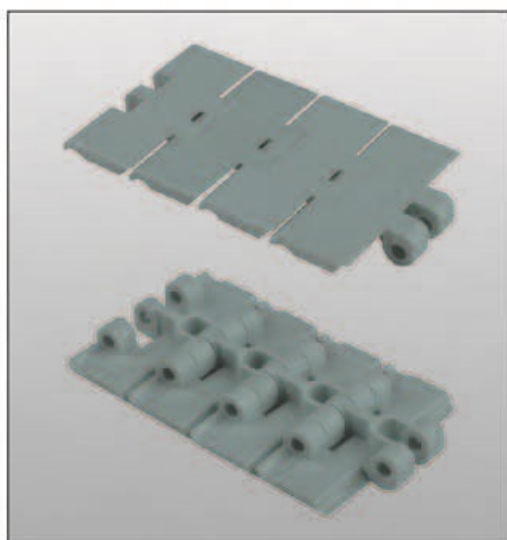

链号 Chain No.	宽度 Width (W)		重量 Weight	
	mm	inch	kg/m	lbs/ft
LF810-K200	50	2	0.42	0.28

- 主要适用于各种食品，饮料，保特瓶，以及各类容器输送。
- 最大输送长度为8米。
- 最高速度：润滑剂 80米/分钟
干燥 50米/分钟
- 工作载荷：800N
- 轴心材质：不锈钢
- 链板材质：POM 塑钢（使用温度：-40~ 90℃）
- 包装：10英尺 = 3.048 米/盒
1米=52片
- Mainly used for all kinds of food industry, such as beverage, bottle, can and other conveyors.
- The longest distance: 8M
- Max. speed: lubricant 80M/min
dryness 50M/min
- Working load: 800N
- Pin material: austenitic stainless steel
- Plate material: POM acetal
(Temperature: -40 ~ 90℃)
- Packing: 10 feet = 3.048 M/box 52pcs/M

LF520 单绞直输链 LF520 CHAIN SINGLE HINGE STRAIGHT RUNNING

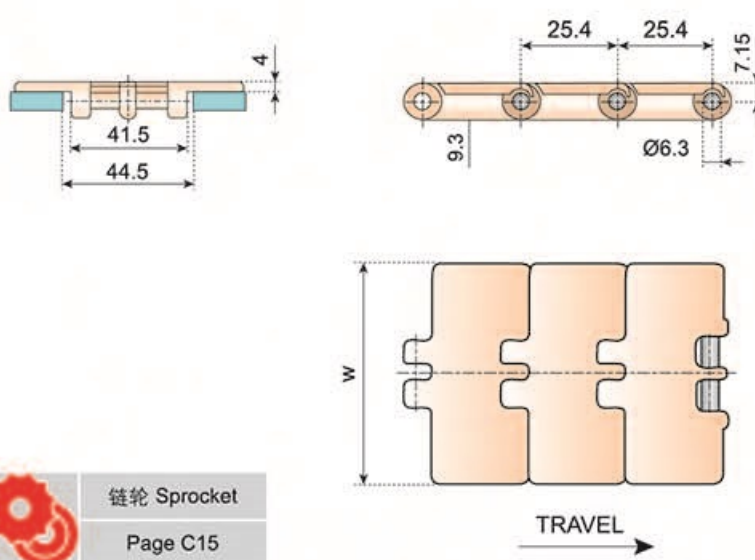

链号 Chain No.	宽度 Width (W)		重量 Weight	
	mm	inch	kg/m	lbs/ft
LF520-K325	82.6	3.25	0.75	0.51

- 主要适用于各种食品，饮料，保特瓶，以及各类容器输送。
- 最大输送长度为12米。
- 最高速度：润滑剂 80米/分钟
干燥 50米/分钟
- 工作载荷：1250N
- 轴心材质：不锈钢
- 链板材质：POM 塑钢（使用温度：-40~ 90℃）
- 包装：10英尺 = 3.048 米/盒
1米=39片
- Mainly used for all kinds of food industry, such as beverage, bottle, can and other conveyors.
- The longest distance: 12M
- Max. speed: lubricant 80M/min
dryness 50M/min
- Working load: 1250N
- Pin material: austenitic stainless steel
- Plate material: POM acetal
(Temperature: -40 ~ 90℃)
- Packing: 10 feet = 3.048 M/box 39pcs/M

塑料平顶链 Plastic Flat Top Chains

LF820 单铰直输链 LF820 SINGLE HINGE STRAIGHT RUNNING

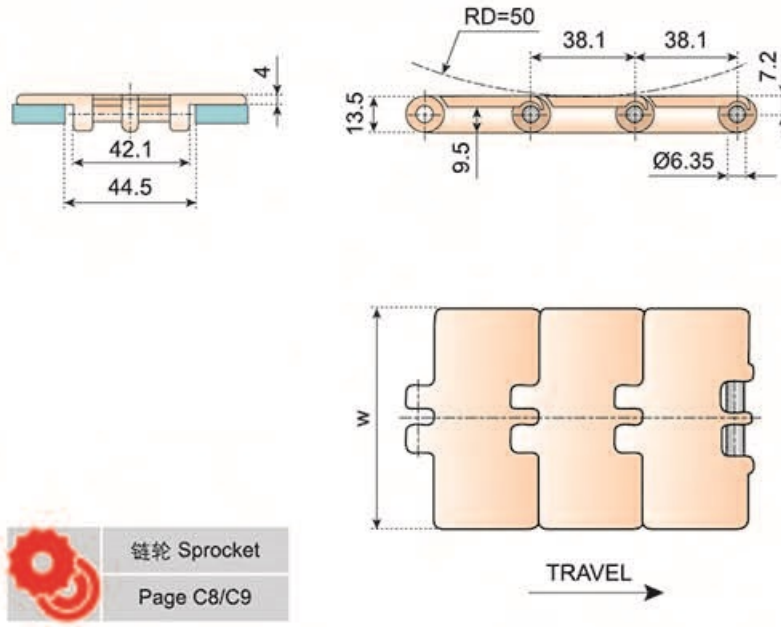

链轮 Sprocket
Page C8/C9

- 主要适用于各种食品，饮料，保特瓶，以及各类容器输送。
- 最大输送长度为12米。
- 最高速度：润滑剂 90米/分钟
干燥 60米/分钟
- 工作载荷：2250N
- 轴心材质：不锈钢
- 链板材质：POM 塑钢（使用温度：-40~90℃）
- 包装：10英尺 = 3.048 米/盒
1米=26片
- Mainly used for all kinds of food industry, such as beverage, bottle, can and other conveyors.
- The longest distance: 12M
- Max. speed: lubricant 90M/min
dryness 60M/min
- Working load: 2250N
- Pin material: austenitic stainless steel
- Plate material: POM acetal
(Temperature: -40 ~ 90°C)
- Packing: 10 feet = 3.048 M/box 26pcs/M

链号 Chain No.	宽度 Width (W)		重量 Weight	
	mm	inch	kg/m	lbs/ft
LF820 - K250	63.5	2.50	0.79	0.53
LF820 - K325	82.6	3.25	0.86	0.58
LF820 - K330	83.8	3.30	0.87	0.59
LF820 - K350	88.9	3.50	0.89	0.60
LF820 - K400	101.6	4.00	0.92	0.62
LF820 - K450	114.3	4.50	1.01	0.68
LF820 - K600	152.4	6.00	1.22	0.82
LF820 - K750	190.5	7.50	1.45	0.98

LF820E 抗静电单铰直输链 LF820E ANTI-STATIC SINGLE HINGE STRAIGHT RUNNING

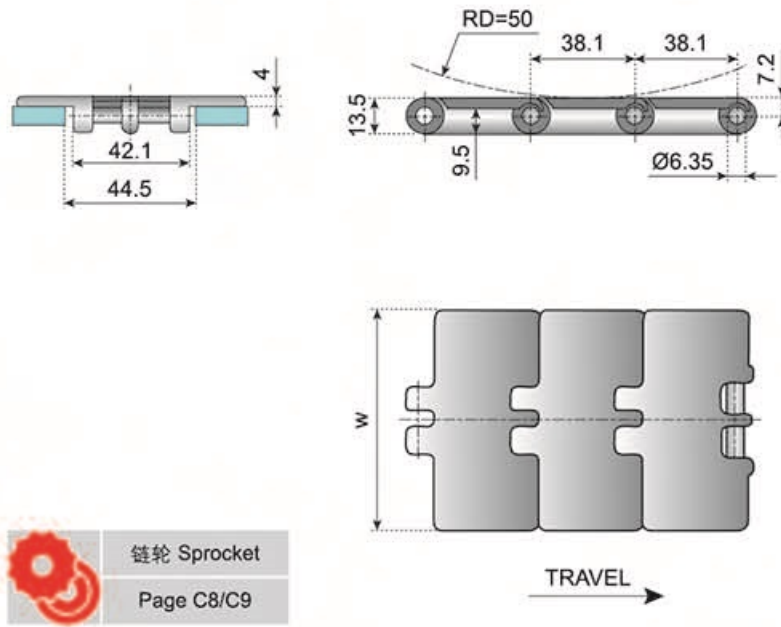

链轮 Sprocket
Page C8/C9

- 主要适用于各种防静电场合的产品输送。
- 最大输送长度为12米。
- 最高速度：润滑剂 80米/分钟
干燥 50米/分钟
- 工作载荷：2250N
- 轴心材质：不锈钢
- 链板材质：抗静电 POM
- 包装：10英尺 = 3.048 米/盒
1米=26片
- Mainly used for different kinds of anti-static conveyor line.
- The longest distance: 12M
- Max. speed: lubricant 80M/min
dryness 50M/min
- Working load: 2250N
- Pin material: austenitic stainless steel
- Plate material: anti-static POM
- Packing: 10 feet = 3.048 M/box 26pcs/M

链号 Chain No.	宽度 Width (W)		重量 Weight	
	mm	inch	kg/m	lbs/ft
LF820 - K250E	63.5	2.50	0.79	0.53
LF820 - K325E	82.6	3.25	0.86	0.58
LF820 - K350E	88.9	3.50	0.89	0.60
LF820 - K400E	101.6	4.00	0.92	0.62
LF820 - K450E	114.3	4.50	1.01	0.68
LF820 - K600E	152.4	6.00	1.22	0.82
LF820 - K750E	190.5	7.50	1.45	0.98

塑料平顶链 Plastic Flat Top Chains

LF820 单铰直输迷你链 LF820 STRAIGHT RUNNING PLASTIC MINI CHAIN

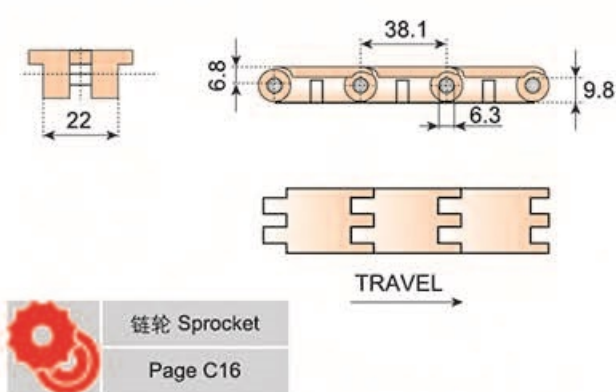
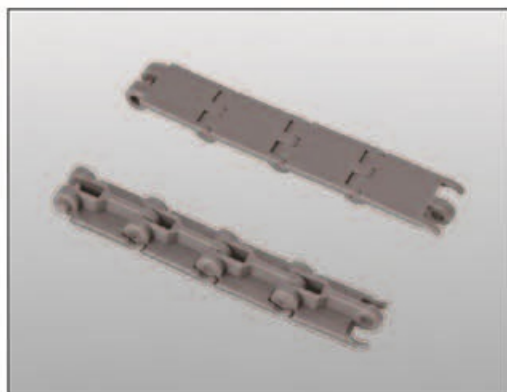

- 主要适用于各种食品、饮料、宝特瓶等各类容器输送
- 包装：一盒=10英尺=3.048米 1米=26片
- 最大输送长度≤12米，最大负载拉力≤1230N
- Mainly used for food beverage, pet and bottles conveying.
- Packing: 10 feet = 3.048m / box 1meter = 26pcs
- Max. conveyor length≤12m Max. tensile strength≤1230N

链号 Chain No.	宽度 Width (W)		重量 Weight	
	mm	inch	kg/m	lbs/ft
LF820mini - K118	30	1.18	0.46	0.31

LF820 单铰直输迷你链 LF820 STRAIGHT RUNNING SINGLE HINGE MINI CHAIN

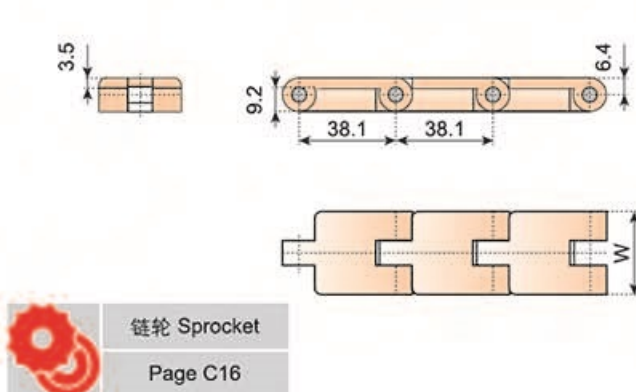

- 主要适用于各种食品、饮料、宝特瓶等各类容器输送
- 包装：一盒=10英尺=3.048米 1米=26片
- 最大输送长度≤12米，最大负载拉力≤1230N
- Mainly used for food beverage, pet and bottles conveying.
- Packing: 10 feet = 3.048m / box 1meter = 26pcs
- Max. conveyor length≤12m Max. tensile strength≤1230N

链号 Chain No.	宽度 Width (W)		重量 Weight	
	mm	inch	kg/m	lbs/ft
LF820mini - K126	32	1.26	0.5	0.34

LF820 单铰直输迷你链 LF820 STRAIGHT RUNNING SINGLE HINGE MINI CHAIN

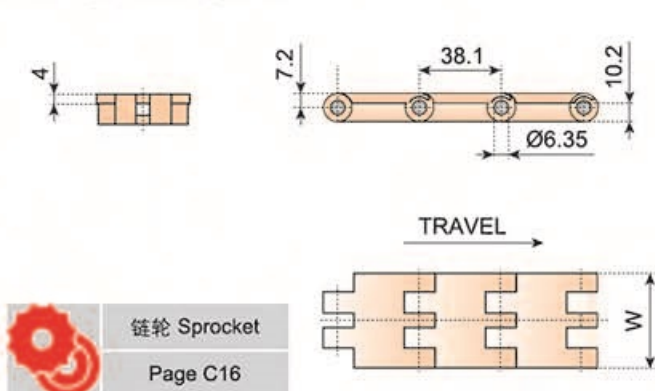
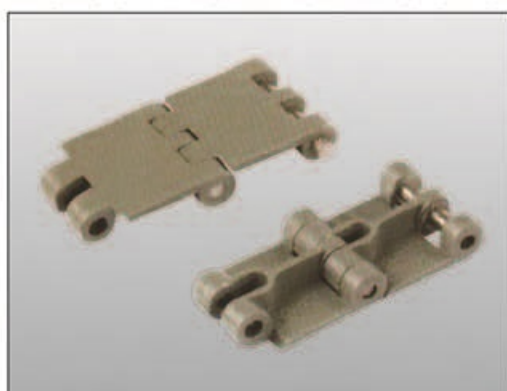

- 主要适用于各种食品、饮料、宝特瓶等各类容器输送
- 包装：一盒=10英尺=3.048米 1米=26片
- 最大输送长度≤12米，最大负载拉力≤1230N
- Mainly used for food beverage, pet and bottles conveying.
- Packing: 10 feet = 3.048m / box 1meter = 26pcs
- Max. conveyor length≤12m Max. tensile strength≤1230N

链号 Chain No.	宽度 Width (W)		重量 Weight	
	mm	inch	kg/m	lbs/ft
LF820mini - K157	40	1.57	0.52	0.35

LF820 单铰直输链板 LF820 STRAIGHT RUNNING PLASTIC CHAIN

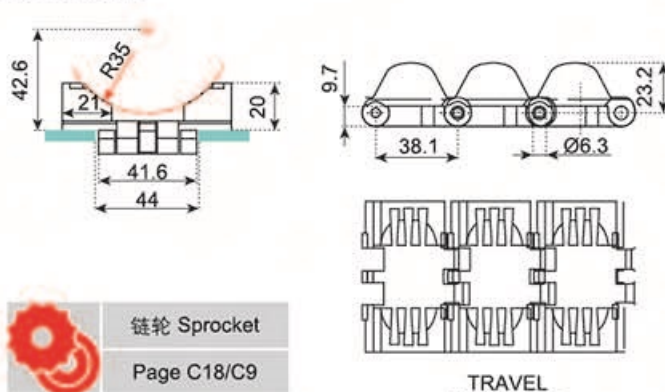
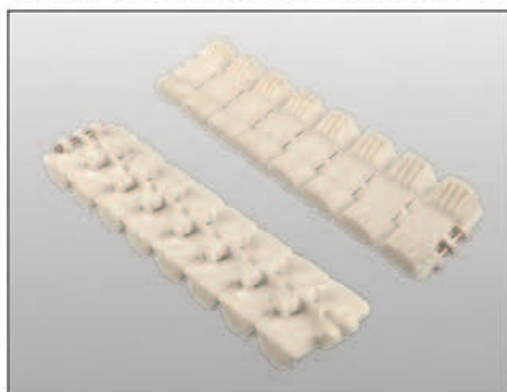

- 主要适用于各种食品、饮料、宝特瓶、铝罐等各类容器输送
- 包装：一盒=10英尺=3.048米 1米=26片
- 最大输送长度≤9米，最大负载拉力≤2000N
- Mainly used for food beverage, pet, bottles and aluminum can conveying.
- Packing: 10 feet = 3.048m / box 1meter = 26pcs
- Max. conveyor length≤9m Max. tensile strength≤2000N

链号 Chain No.	宽度 Width (W)		重量 Weight	
	mm	inch	kg/m	lbs/ft
LF820 - K283	72	2.83	1.57	1.06

LF820 配提升滚珠挡块链板 LF820 PLASTIC LIFTING CHAIN WITH ROLLERS

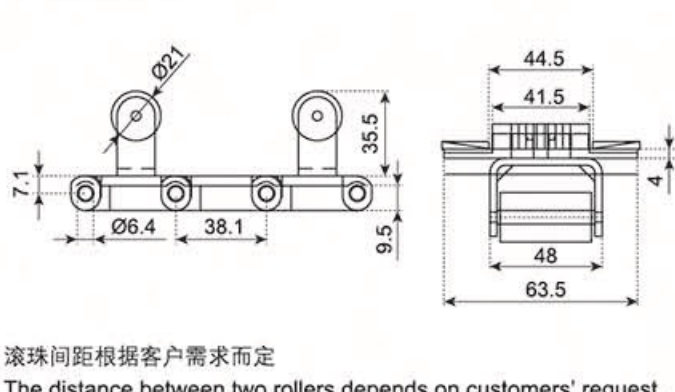
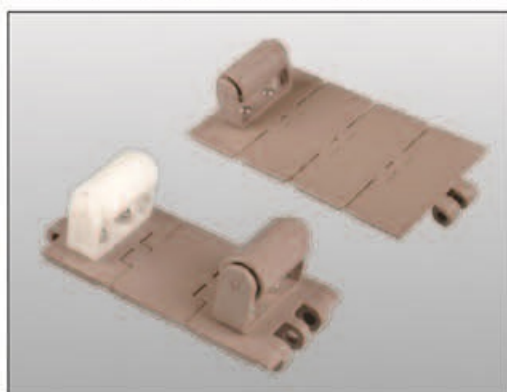

- 主要适用于各种食品、饮料、宝特瓶、铝罐等各类容器输送
- 包装：一盒=10英尺=3.048米 1米=26片
- 最大输送长度≤9米，最大负载拉力≤2000N
- Mainly used for food beverage, pet, bottles and aluminum can conveying.
- Packing: 10 feet = 3.048m / box 1meter = 26pcs
- Max. conveyor length≤9m Max. tensile strength≤2000N

链号 Chain No.	宽度 Width (W)		重量 Weight	
	mm	inch	kg/m	lbs/ft
LF820 - K325 - R	82.6	3.25	0.85	0.57

塑料平顶链 Plastic Flat Top Chains

LF831 单铰直输链 LF831 SINGLE HINGE STRAIGHT RUNNING

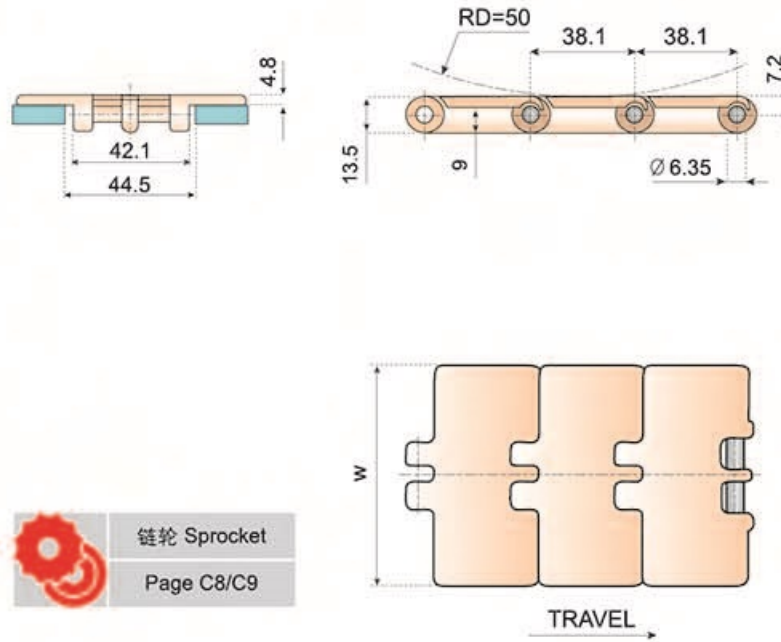

链轮 Sprocket
Page C8/C9

- 主要适用于各种食品，饮料，保特瓶，以及各类容器输送。
- 最大输送长度为12米。
- 最高速度：润滑剂 90米/分钟
干燥 60米/分钟
- 工作载荷：2250N
- 轴心材质：不锈钢
- 链板材质：POM 塑钢（使用温度：-40~90℃）
- 包装：10英尺 = 3.048 米/盒
1米=26片
- Mainly used for all kinds of food industry, such as beverage, bottle, can and other conveyors.
- The longest distance: 12M
- Max. speed: lubricant 90M/min
dryness 60M/min
- Working load: 2250N
- Pin material: austenitic stainless steel
- Plate material: POM acetal
(Temperature: -40 ~ 90°C)
- Packing: 10 feet = 3.048 M/box 26pcs/M

链号 Chain No.	宽度 Width (W)		重量 Weight	
	mm	inch	kg/m	lbs/ft
LF831 - K325	82.6	3.25	0.95	0.64
LF831 - K450	114.3	4.50	1.11	0.75
LF831 - K750	190.5	7.50	1.6	1.08

LF821 双铰直输链 LF821 DOUBLE HINGE STRAIGHT RUNNING

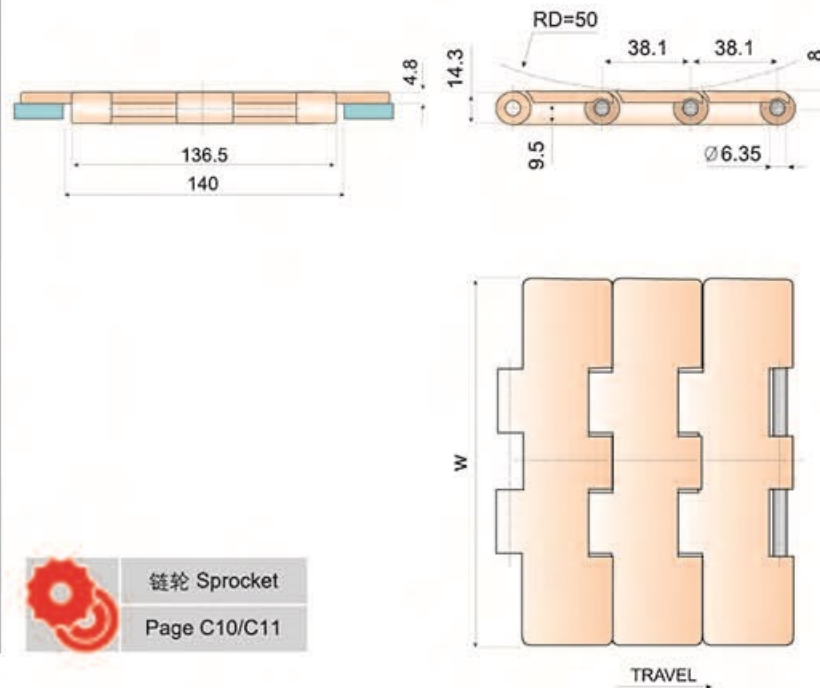

链轮 Sprocket
Page C10/C11

- 主要适用于各种食品，饮料，保特瓶，以及各类容器输送。
- 最大输送长度为12米。
- 最高速度：润滑剂 90米/分钟
干燥 60米/分钟
- 工作载荷：3000N
- 轴心材质：不锈钢
- 链板材质：POM 塑钢（使用温度：-40~90℃）
- 包装：10英尺 = 3.048 米/盒
1米=26片
- Mainly used for all kinds of food industry, such as beverage, bottle, can and other conveyors.
- The longest distance: 12M
- Max. speed: lubricant 90M/min
dryness 60M/min
- Working load: 3000N
- Pin material: austenitic stainless steel
- Plate material: POM acetal
(Temperature: -40 ~ 90°C)
- Packing: 10 feet = 3.048 M/box 26pcs/M

链号 Chain No.	宽度 Width (W)		重量 Weight	
	mm	inch	kg/m	lbs/ft
LF821 - K750	190.5	7.50	2.74	1.84
LF821 - K1000	254.0	10.00	3.21	2.16
LF821 - K1200	304.8	12.00	3.42	2.30

塑料平顶链 Plastic Flat Top Chains

LF880 燕尾八字型转弯平顶链 LF880 BEVEL SIDEFLEXING

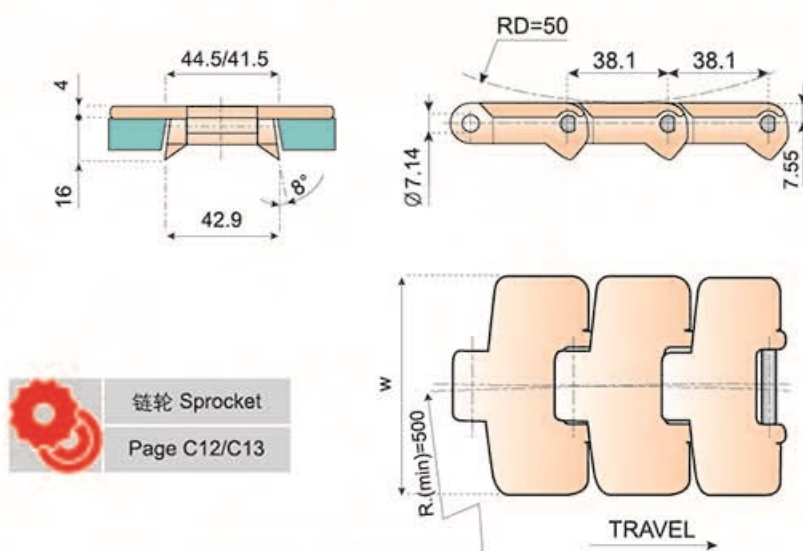
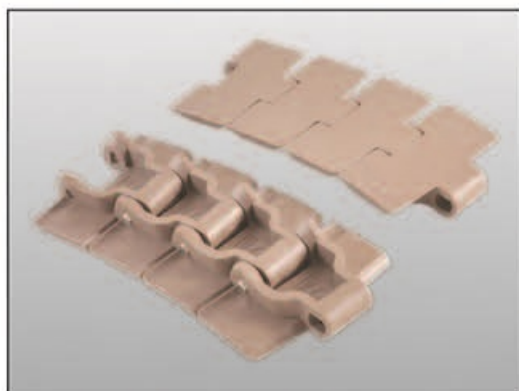

链轮 Sprocket
Page C12/C13

- 主要适用于各种食品，饮料，保持瓶，以及各类容器输送。
- 最大输送长度为9米。
- 最高速度：润滑剂 90米/分钟
干燥 60米/分钟
- 工作载荷：2250N
- 轴心材质：不锈钢
- 链板材质：POM 塑钢（使用温度：-40~90℃）
- 包装：10英尺 = 3.048 米/盒
1米=26片
- Mainly used for all kinds of food industry, such as beverage, bottle, can and other conveyors.

链号 Chain No.	宽度 Width (W)		重量 Weight	
	mm	inch	kg/m	lbs/ft
LF880 - K325	82.6	3.25	0.89	0.60
LF880 - K450	114.3	4.50	1.05	0.71

LF880TAB 有翼型转弯平顶链 LF880TAB SIDEFLEXING

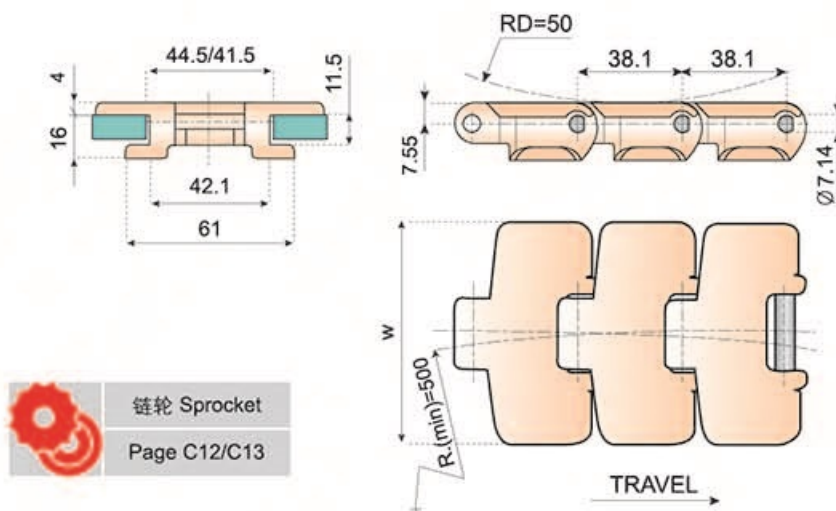

链轮 Sprocket
Page C12/C13

- The longest distance: 9M
- Max. speed: lubricant 90M/min
dryness 60M/min
- Working load: 2250N
- Pin material: austenitic stainless steel
- Plate material: POM acetal
(Temperature: -40 ~ 90℃)
- Packing: 10 feet = 3.048 M/box 26pcs/M

链号 Chain No.	宽度 Width (W)		重量 Weight	
	mm	inch	kg/m	lbs/ft
LF880TAB - K325	82.6	3.25	1.08	0.73
LF880TAB - K450	114.3	4.50	1.21	0.81

LF880TAB 防静电有翼型转弯平顶链防静电 LF880TAB ANTI-STATIC SIDEFLEXING

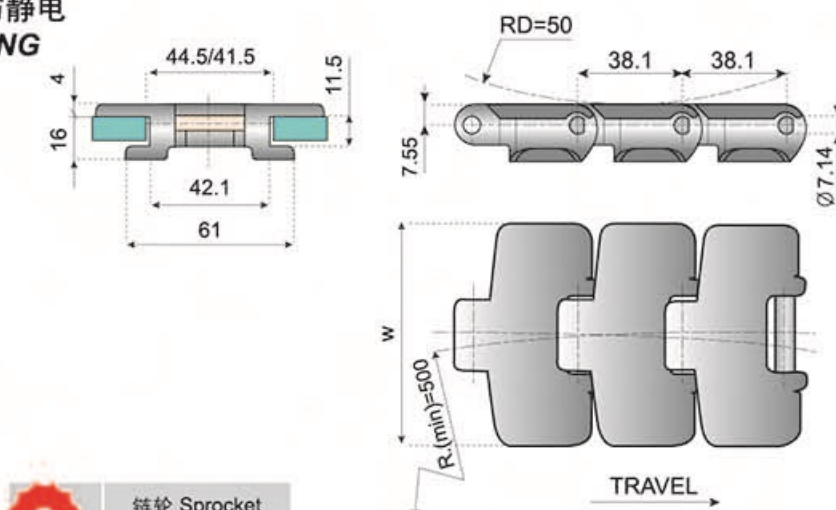

链轮 Sprocket
Page C12/C13

- 主要适用于各种防静电场合的产品输送。
- 最大输送长度为9米。
- 最高速度：润滑剂 90米/分钟
干燥 60米/分钟
- 工作载荷：2250N
- 轴心材质：不锈钢
- 链板材质：防静电 POM
- 包装：10英尺 = 3.048 米/盒
1米=26片
- Mainly used for different kinds of anti-static conveyor line.
- The longest distance: 9M
- Max. speed: lubricant 90M/min
dryness 60M/min
- Working load: 2250N
- Pin material: austenitic stainless steel
- Plate material: anti-static POM
- Packing: 10 feet = 3.048 M/box 26pcs/M

链号 Chain No.	宽度 Width (W)		重量 Weight	
	mm	inch	kg/m	lbs/ft
LF880TAB - K325E	82.6	3.25	1.08	0.73
LF880TAB - K450E	114.3	4.50	1.21	0.81

塑料平顶链 Plastic Flat Top Chains

LF880M 无导型磁性转弯平顶链 LF880M MAGNETIC SIDEFLEXING

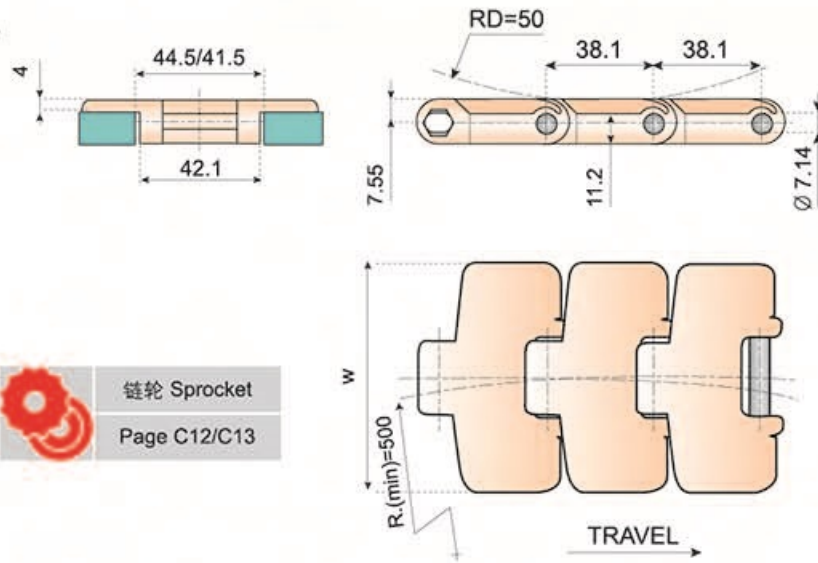
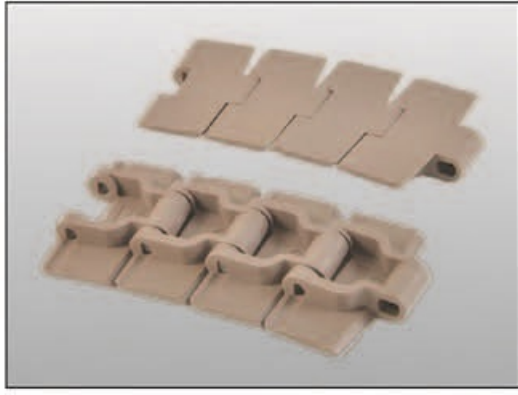

链轮 Sprocket
Page C12/C13

- 主要适用于各种食品，饮料，保特瓶，以及各类容器输送。
- 最大输送长度为9米。
- 最高速度：润滑剂 90米/分钟
干燥 60米/分钟
- 工作载荷：2250N
- 轴心材质：不锈钢
- 链板材质：POM 塑钢（使用温度：-40~90℃）
- 包装：10英尺 = 3.048 米/盒 1米=26片
- Mainly used for all kinds of food industry, such as beverage, bottle, can and other conveyors.
- The longest distance: 9M
- Max. speed: lubricant 90M/min
dryness 60M/min
- Working load: 2250N
- Pin material: ferritic stainless steel
- Plate material: POM acetal
(Temperature: -40 ~ 90℃)
- Packing: 10 feet = 3.048 M/box 26pcs/M

链号 Chain No.	宽度 Width (W)		重量 Weight	
	mm	inch	kg/m	lbs/ft
LF880M - K325	82.6	3.25	1.03	0.71
LF880M - K330	83.8	3.30	1.05	0.72
LF880M - K450	114.3	4.50	1.15	0.77

LF880BS 小半径侧弯链 LF880BS SIDEFLEXING

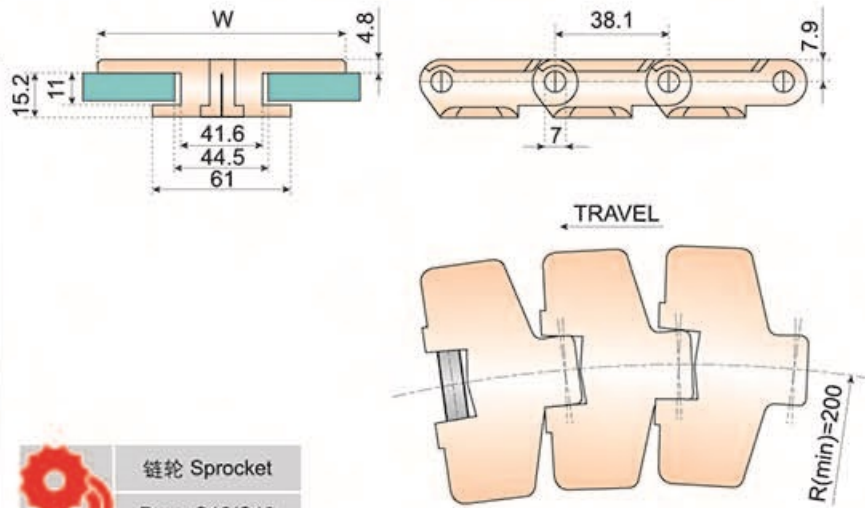
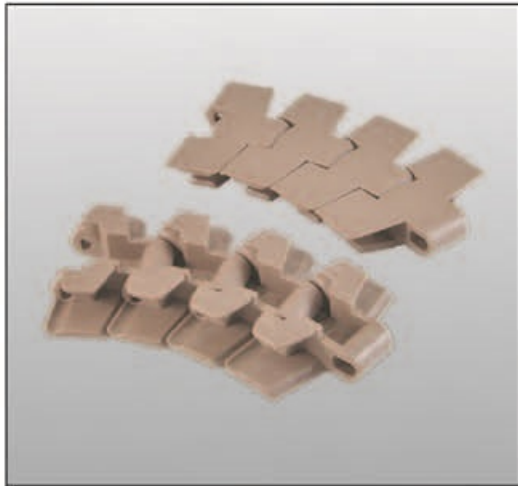

链轮 Sprocket
Page C12/C13

- 主要适用于各种食品，饮料，保特瓶，以及各类容器输送。
- 最大输送长度为9米。
- 最高速度：润滑剂 90米/分钟
干燥 60米/分钟
- 工作载荷：2250N
- 轴心材质：不锈钢
- 链板材质：POM 塑钢（使用温度：-40~90℃）
- 包装：10英尺 = 3.048 米/盒 1米=26片
- Mainly used for all kinds of food industry, such as beverage, bottle, can and other conveyors.
- The longest distance: 9M
- Max. speed: lubricant 90M/min
dryness 60M/min
- Working load: 2250N
- Pin material: austenitic stainless steel
- Plate material: POM acetal
(Temperature: -40 ~ 90℃)
- Packing: 10 feet = 3.048 M/box 26pcs/M

链号 Chain No.	宽度 Width (W)		重量 Weight	
	mm	inch	kg/m	lbs/ft
LF880BS - K325	82.6	3.25	1.05	0.71
LF880BS - K450	114.3	4.50	1.15	0.77

LF878TAB 有翼型转弯平顶链 LF878TAB SIDEFLEXING

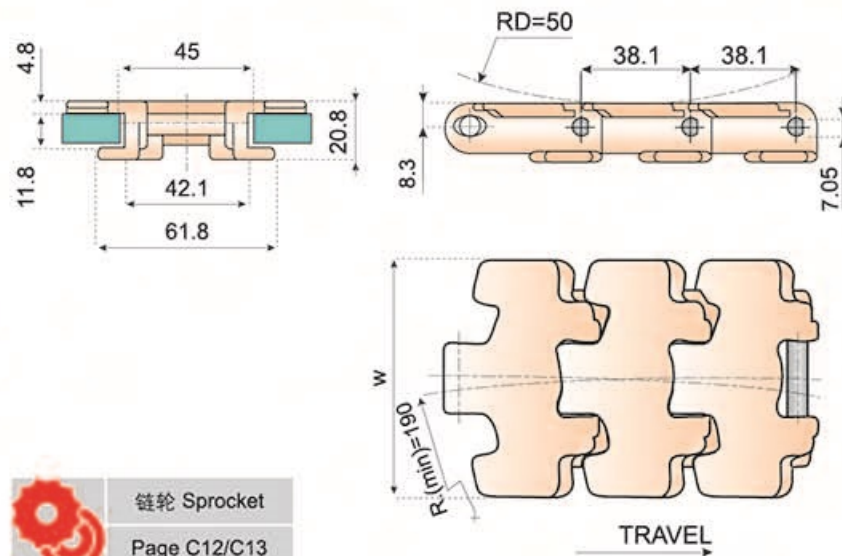

链轮 Sprocket
Page C12/C13

- 主要适用于各种食品，饮料，保特瓶，以及各类容器输送。
- 最大输送长度为9米。
- 最高速度：润滑剂 90米/分钟
干燥 60米/分钟
- 工作载荷：2250N
- 轴心材质：不锈钢
- 链板材质：POM 塑钢（使用温度：-40~90℃）
- 包装：10英尺 = 3.048 米/盒 1米=26片
- Mainly used for all kinds of food industry, such as beverage, bottle, can and other conveyors.
- The longest distance: 9M
- Max. speed: lubricant 90M/min
dryness 60M/min
- Working load: 2250N
- Pin material: austenitic stainless steel
- Plate material: POM acetal
(Temperature: -40 ~ 90℃)
- Packing: 10 feet = 3.048 M/box 26pcs/M

链号 Chain No.	宽度 Width (W)		重量 Weight	
	mm	inch	kg/m	lbs/ft
LF878TAB - K325	82.5	3.25	1.08	0.73
LF878TAB - K450	114.3	4.50	1.21	0.81

塑料平顶链 Plastic Flat Top Chains

LF882 燕尾八字型转弯平顶链 LF882 BEVEL SIDEFLEXING

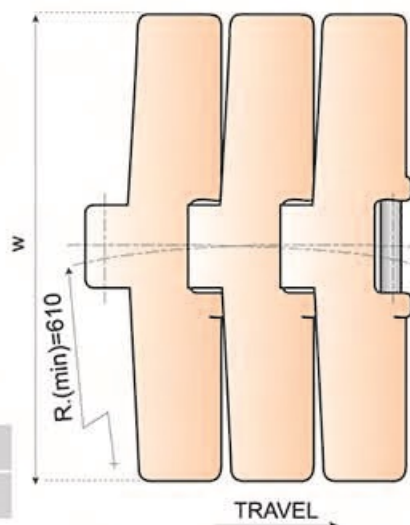
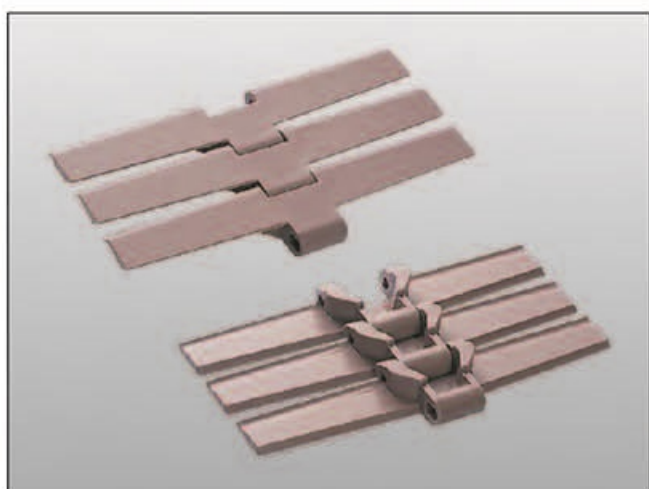
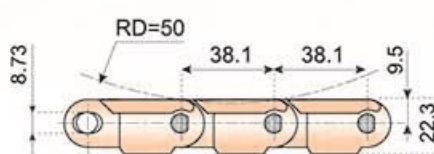
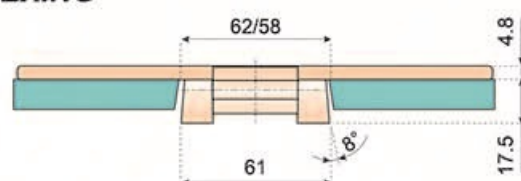

- 主要适用于各种食品，饮料，保特瓶，以及各类容器输送。
- 最大输送长度为12米。
- 最高速度：润滑剂 90米/分钟
干燥 60米/分钟
- 工作载荷：2250N
- 轴心材质：不锈钢
- 链板材质：POM 塑钢（使用温度：-40~90℃）
- 包装：10英尺 = 3.048 米/盒
1米=26片
- Mainly used for all kinds of food industry, such as beverage, bottle, can and other conveyors.
- The longest distance: 12 M
- Max. speed: lubricant 90M/min
dryness 60M/min
- Working load: 2250N
- Pin material: austenitic stainless steel
- Plate material: POM acetal
(Temperature: -40 ~ 90℃)
- Packing: 10 feet = 3.048 M/box 26pcs/M

链号 Chain No.	宽度 Width (W)		重量 Weight	
	mm	inch	kg/m	lbs/ft
LF882 - K325	82.6	3.25	1.05	0.70
LF882 - K450	114.3	4.50	1.94	1.30
LF882 - K600	152.4	6.00	2.10	1.40
LF882 - K750	190.5	7.50	2.38	1.60
LF882 - K1000	254.0	10.00	2.83	1.90
LF882 - K1200	304.8	12.00	3.37	2.27

LF882TAB 有翼型转弯平顶链 LF882TAB SIDEFLEXING

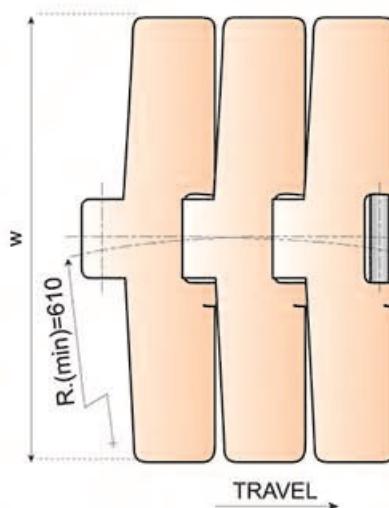
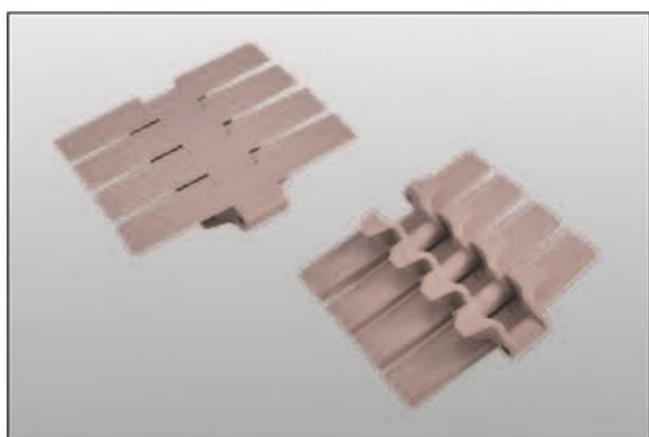
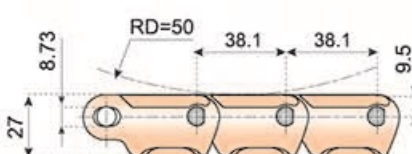
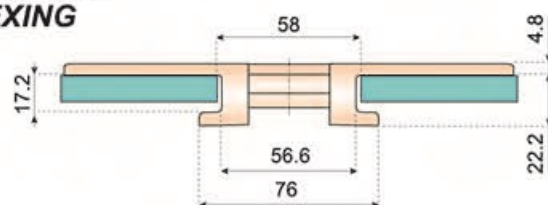

- 主要适用于各种食品，饮料，保特瓶，以及各类容器输送。
- 最大输送长度为12米。
- 最高速度：润滑剂 90米/分钟
干燥 60米/分钟
- 工作载荷：2250N
- 轴心材质：不锈钢
- 链板材质：POM 塑钢（使用温度：-40~90℃）
- 包装：10英尺 = 3.048 米/盒
1米=26片
- Mainly used for all kinds of food industry, such as beverage, bottle, can and other conveyors.
- The longest distance: 12 M
- Max. speed: lubricant 90M/min
dryness 60M/min
- Working load: 2250N
- Pin material: austenitic stainless steel
- Plate material: POM acetal
(Temperature: -40 ~ 90℃)
- Packing: 10 feet = 3.048 M/box 26pcs/M

链号 Chain No.	宽度 Width (W)		重量 Weight	
	mm	inch	kg/m	lbs/ft
LF882TAB - K325	82.6	3.25	1.76	1.20
LF882TAB - K450	114.3	4.50	2.03	1.37
LF882TAB - K600	152.4	6.00	2.20	1.48
LF882TAB - K750	190.5	7.50	2.46	1.66
LF882TAB - K1000	254	10.00	2.80	1.89
LF882TAB - K1200	304.8	12.00	3.05	2.06
LF882TAB - K1600	406.4	16.00	3.45	2.33

滚珠直输链 *Straight Running Chains with Low Noise Accumulation Rollers*

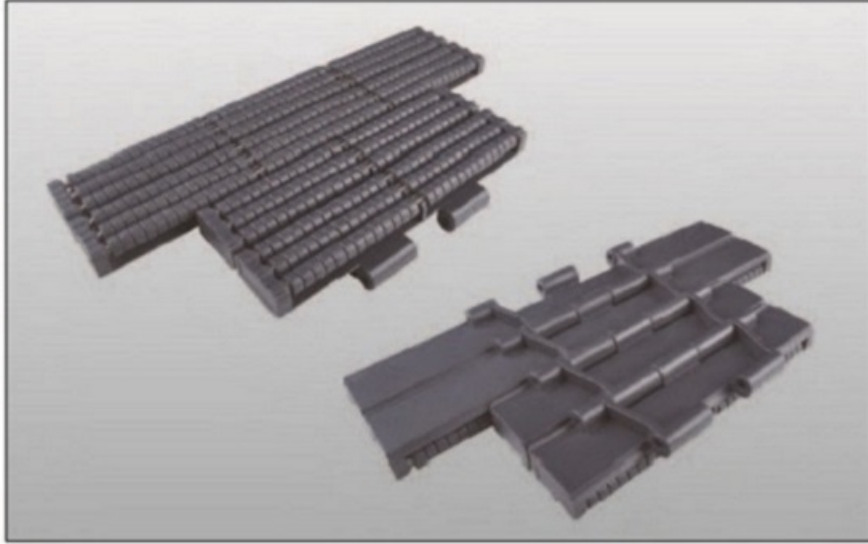

LBP821 滚珠双铰直输平顶链
LBP821 DOUBLE HINGE STRAIGHT RUNNING
with low noise accumulation rollers

链号 Chain No.	宽度 Width (W)		重量 Weight kg/m
	mm	inch	
LBP821 - K750	190.5	7.5	5.4
LBP821 - K1000	254.0	10	6.8
LBP821 - K1200	304.8	12	8.1



链轮 Sprocket
Page C10/C11

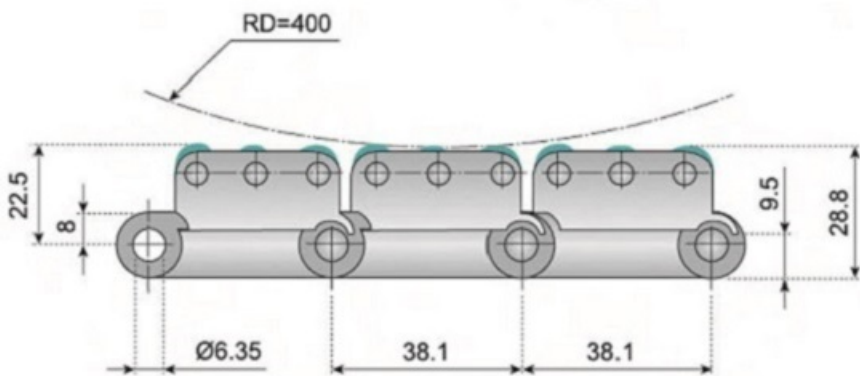

- 主要适用于各种食品，饮料，保特瓶，铝罐等收缩膜或纸箱包装线输送。
- 最大输送长度为12米。
- 工作载荷：2750N
- 轴心材质：不锈钢
- 链板及滚珠材质：POM 塑钢（使用温度：-40~90℃）
- 包装：5英尺 = 1.524 米/盒
1米=26片
- Mainly used for all kinds of food industry, such as beverage, bottle, can and other conveyors wrap packing.
- The longest distance: 12M
- Working load: 2750N
- Pin material: austenitic stainless steel
- Plate and rollers material: POM acetal (Temperature: -40 ~ 90°C)
- Packing: 5 feet = 1.524 M/box 26pcs/M

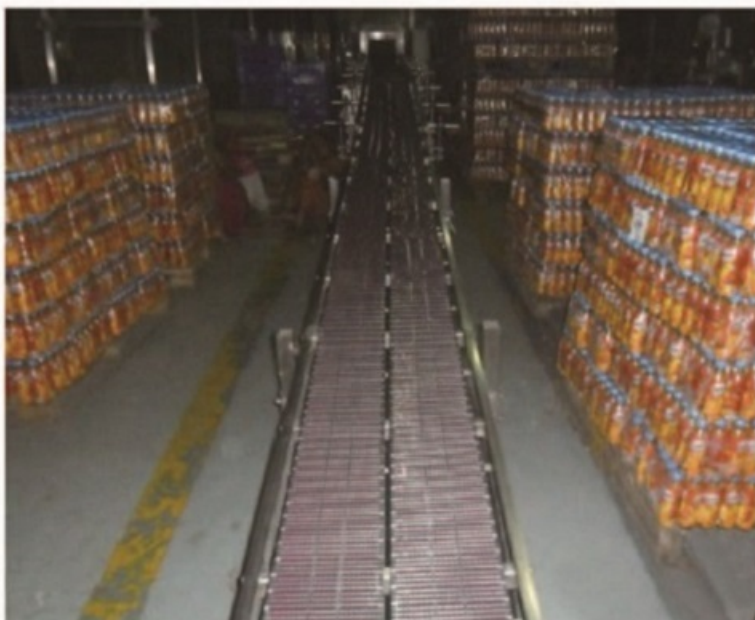
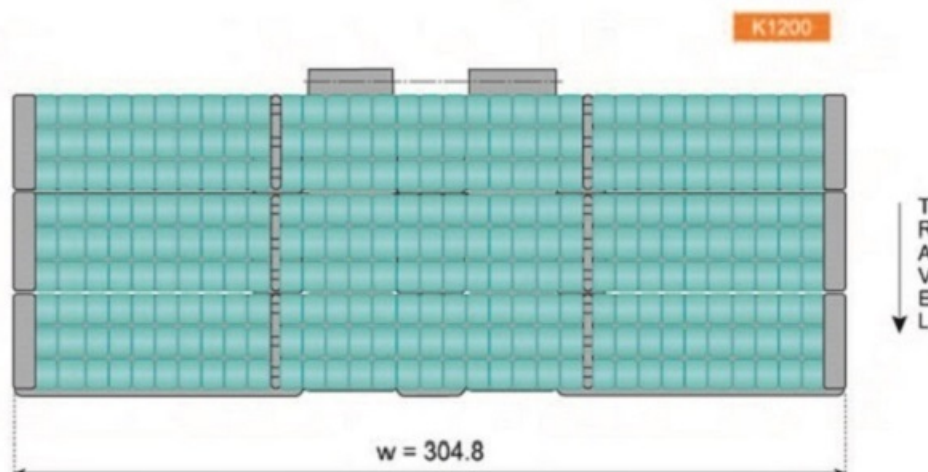
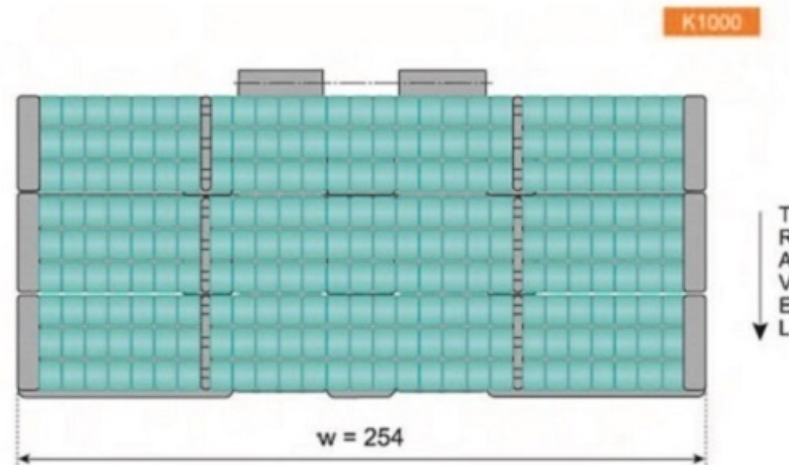
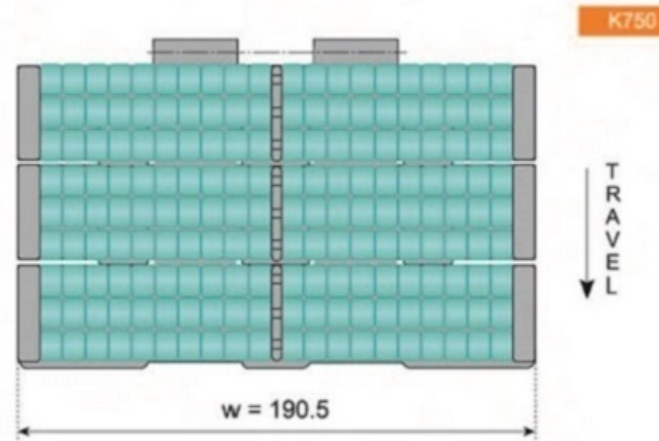
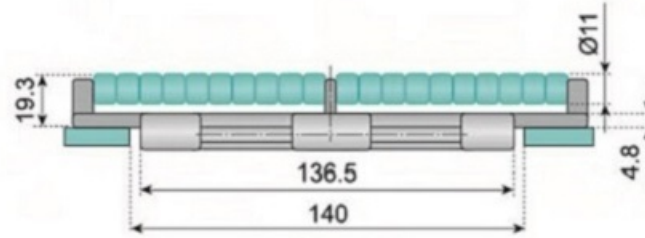

重载滚珠单铰直输链 *Straight Running Chains with Low Noise Accumulation Rollers*

LBP8257 重载滚珠单铰直输链
LBP8257 HEAVY DUTY SINGLE HINGE STRAIGHT RUNNING CHAINS
with low noise accumulation rollers

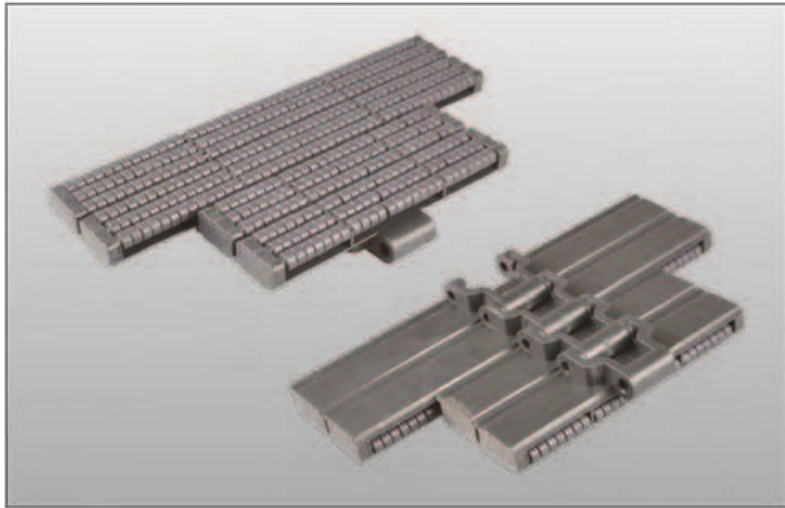

链号 Chain No.	宽度 Width (W)		重量 Weight kg/m
	mm	inch	
LBP8257 - K750	190.5	7.5	5.6
LBP8257 - K1000	254.0	10	7.2
LBP8257 - K1200	304.8	12	8.1

 链轮 Sprocket
Page C13/C14

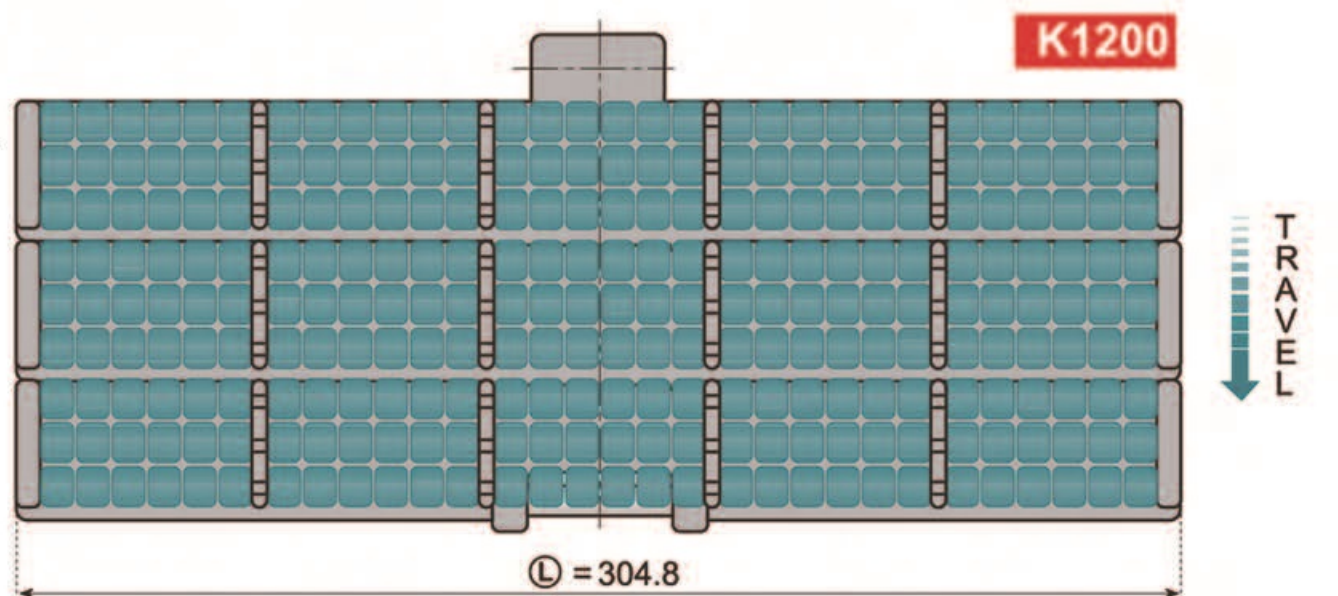
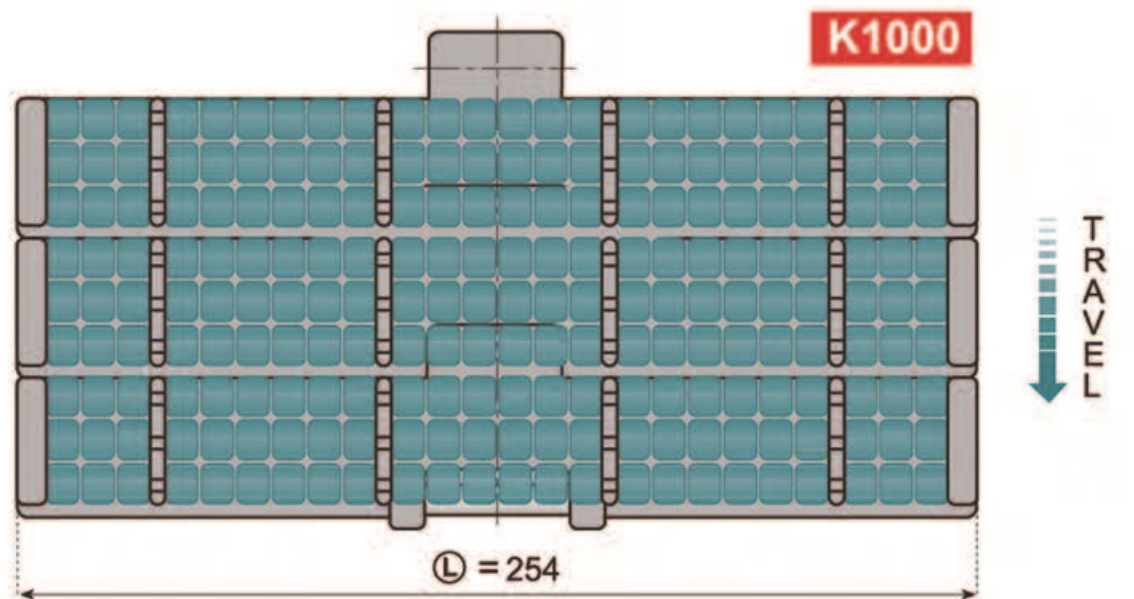
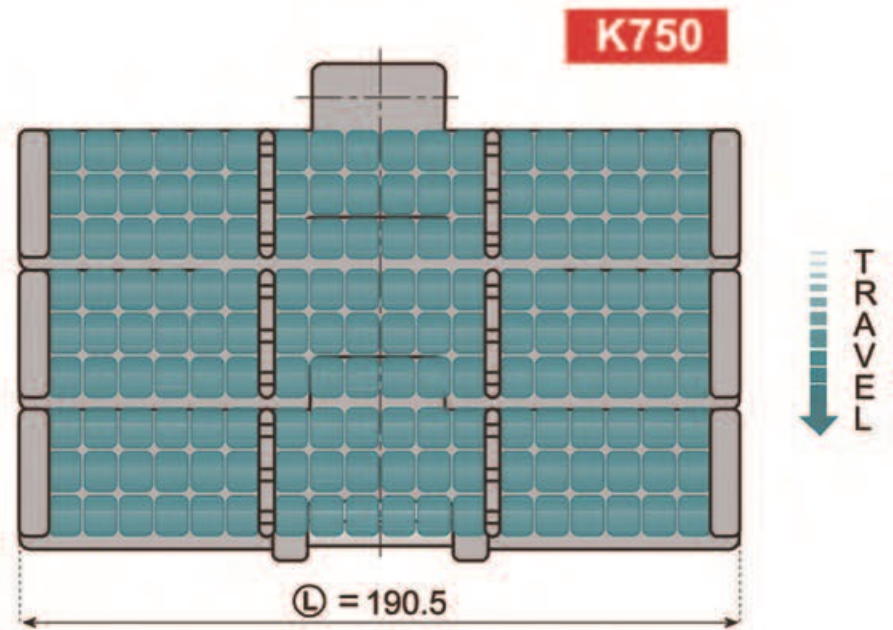
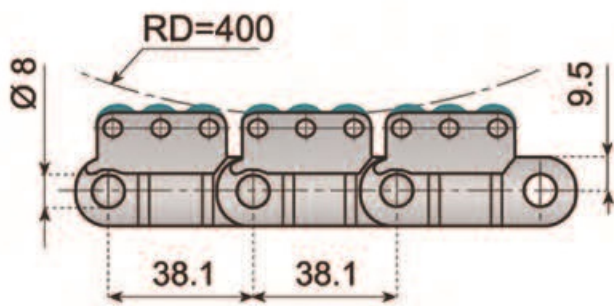
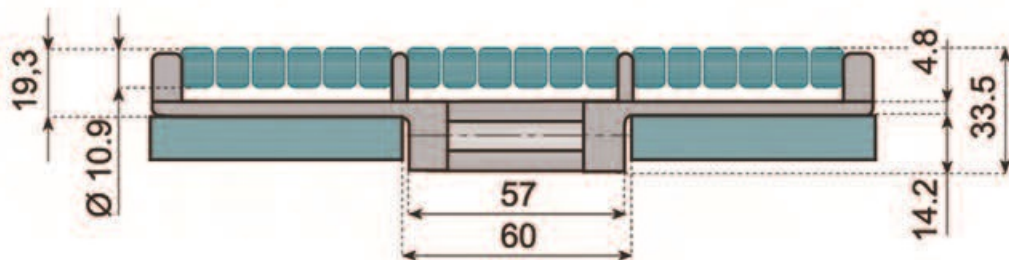

- 主要适用于各种食品，饮料，保特瓶，铝罐等收缩膜或纸箱包装线输送。
- 最大输送长度为12米。
- 工作载荷：2750N
- 轴心材质：不锈钢
- 链板及滚珠材质：POM 塑钢（使用温度：-40~90℃）
- 包装：5英尺 = 1.524 米/盒
1米=26片
- Mainly used for all kinds of food industry, such as beverage, bottle, can and other conveyors wrap packing.
- The longest distance: 12M
- Working load: 2750N
- Pin material: austenitic stainless steel
- Plate and rollers material: POM acetal (Temperature: -40 ~ 90℃)
- Packing: 5 feet = 1.524 M/box 26pcs/M

滚珠直输链 *Straight Running Chains with Low Noise Accumulation Rollers*

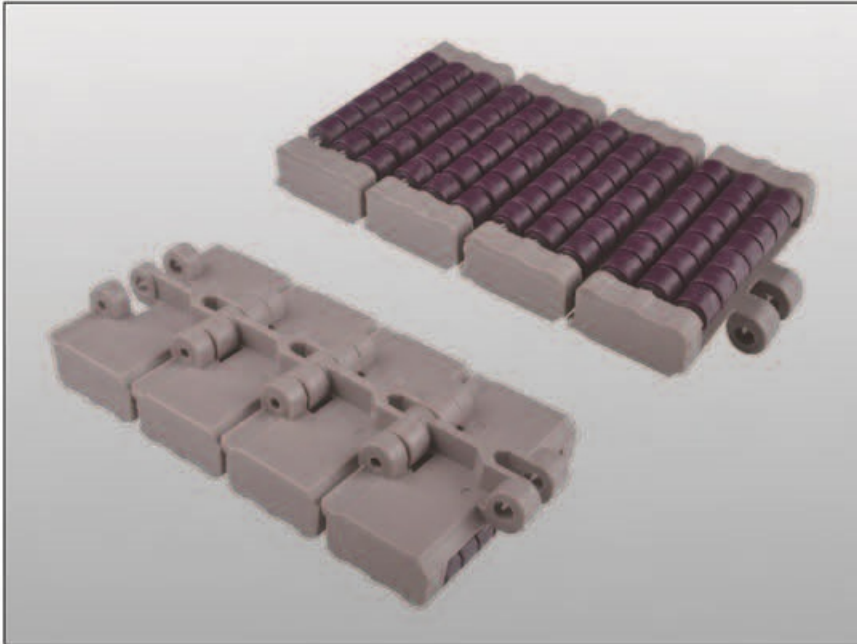

LBP831 滚珠单铰直输平顶链
LBP831 SINGLE HINGE STRAIGHT RUNNING
with low noise accumulation rollers

链号 Chain No.	宽度 Width (W)		重量 Weight kg/m
	mm	inch	
LBP831 - K325	82.5	3.25	2.2
LBP831 - K450	114.3	4.5	2.6



链轮 Sprocket

Page C8/C9

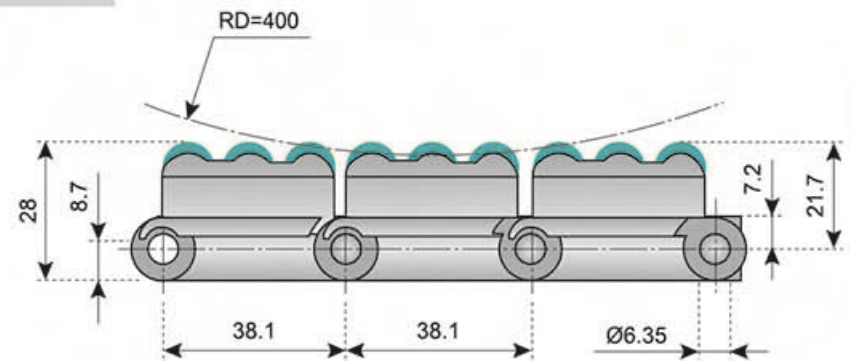
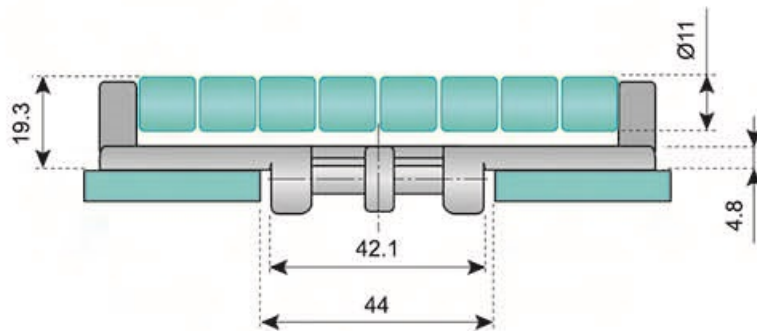

- 主要适用于各种食品，饮料，保特瓶，铝罐等收缩膜或纸箱包装线输送。
- 最大输送长度为12米。
- 工作载荷：2750N
- 轴心材质：不锈钢
- 链板及滚珠材质：POM 塑钢（使用温度：-40~90℃）
- 包装：10英尺 = 3.048 米/盒
1米=26片
- Mainly used for all kinds of food industry, such as beverage, bottle, can and other conveyors wrap packing.
- The longest distance: 12M
- Working load: 2750N
- Pin material: austenitic stainless steel
- Plate and rollers material: POM acetal (Temperature: -40 ~ 90°C)
- Packing: 10 feet = 3.048 M/box 26pcs/M

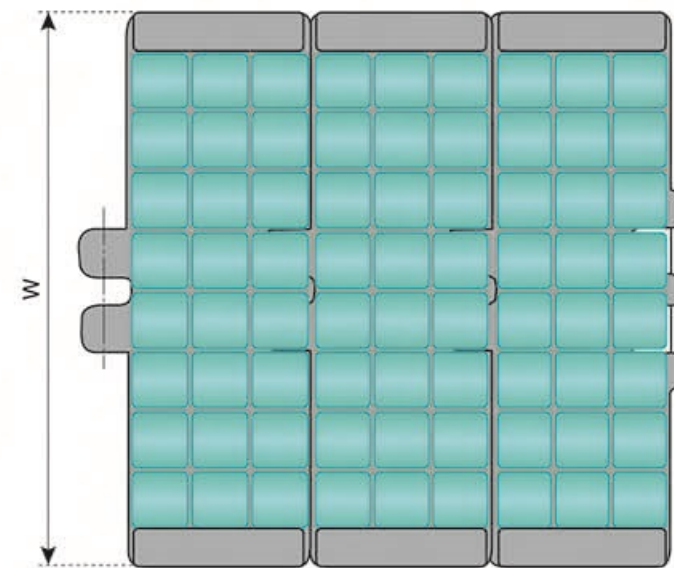

TRAVEL →



滚珠转弯链 Sideflexing Chains with Low Noise Accumulation Rollers

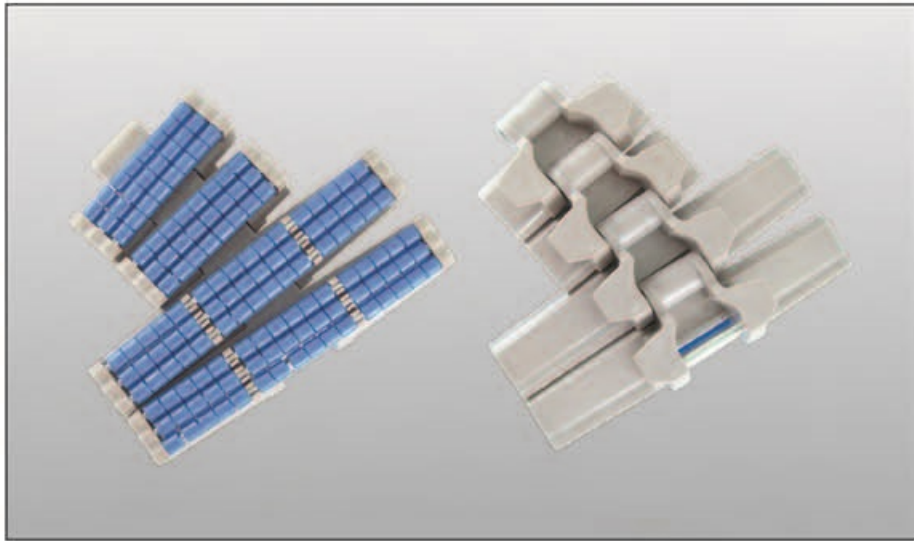

LBP882TAB 滚珠转弯平顶链
LBP882TAB SIDEFLEXING with low noise accumulation rollers

链号 Chain No.	宽度 Width (W)		重量 Weight kg/m
	mm	inch	
LBP882TAB - K375	95.3	3.75	3.3
LBP882TAB - K450	114.3	4.5	3.5
LBP882TAB - K600	152.4	6.0	4.0
LBP882TAB - K750	190.5	7.5	4.5
LBP882TAB - K1000	254	10	5.7
LBP882TAB - K1200	304.8	12	6.3

链轮 Sprocket
 Page C13/C14

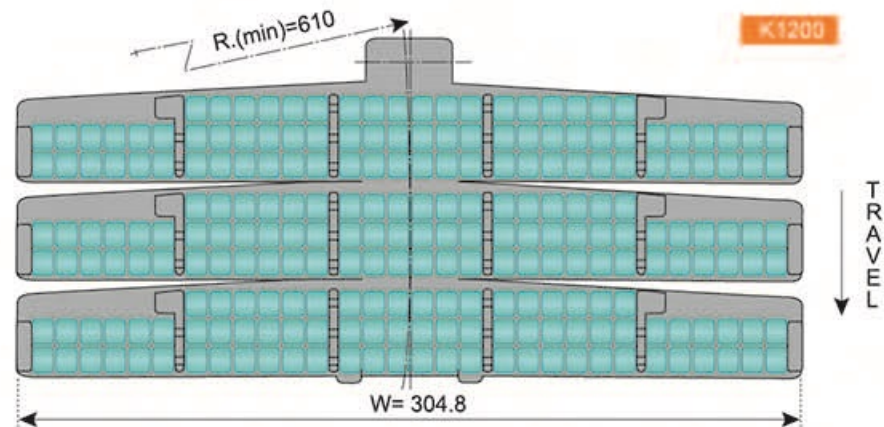
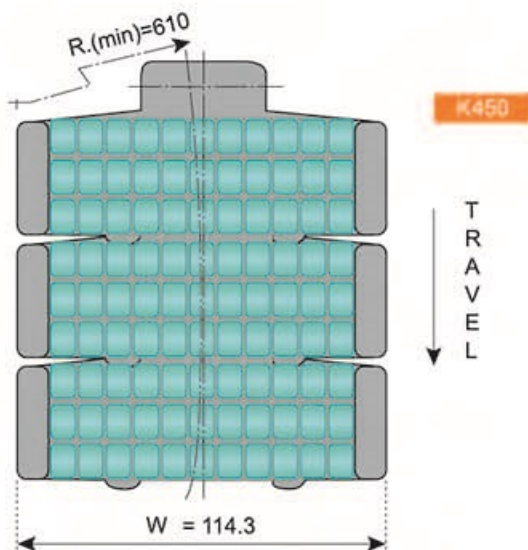
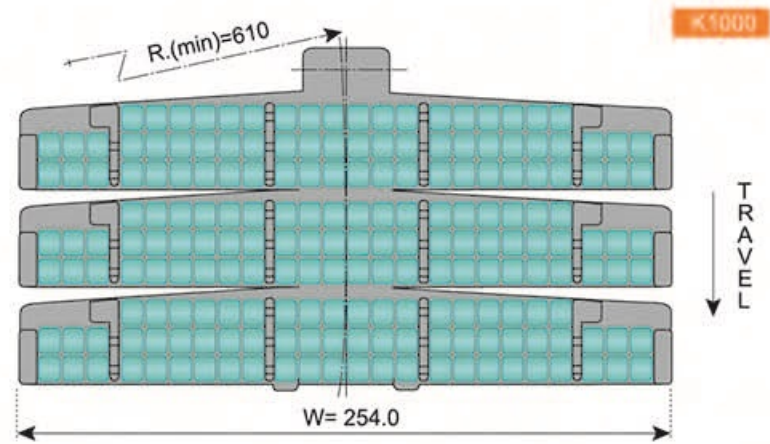
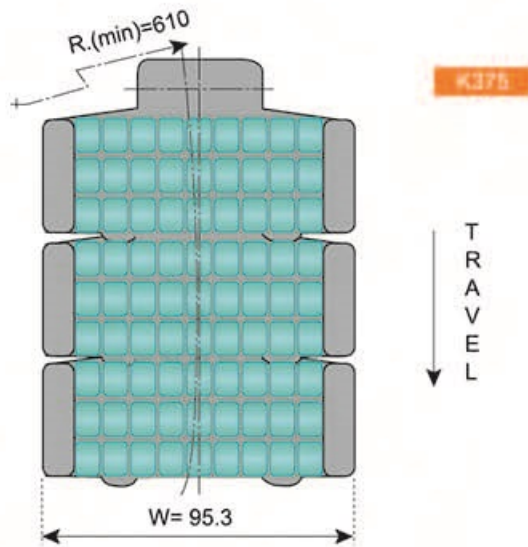
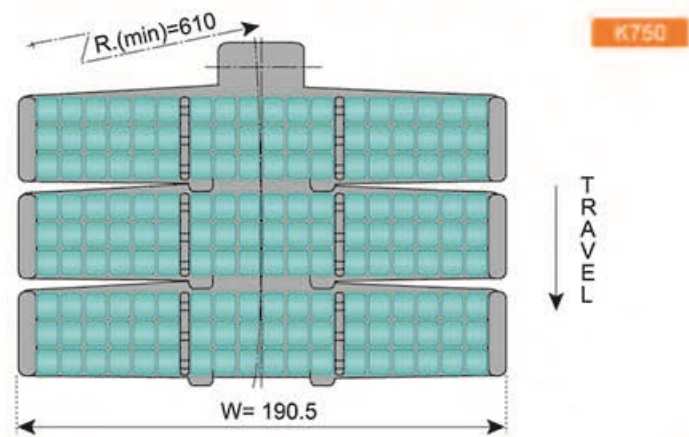
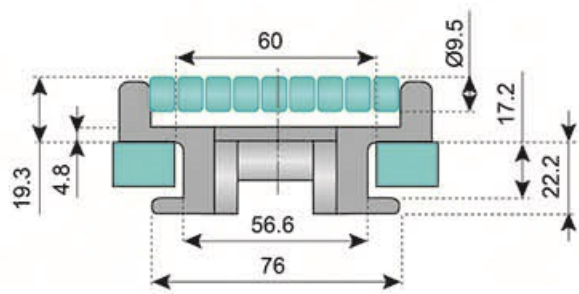
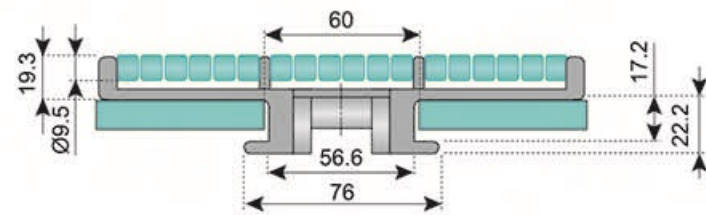
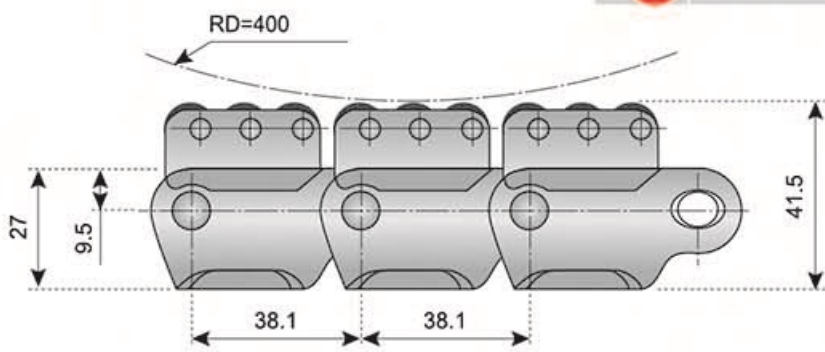

磁性重载单铰转弯滚珠链 SIDEFLEXING CHAINS FOR MAGNETIC SYSTEM HEAVY DUTY SINGLE HINGE

LBP882M 磁性重载单铰转弯滚珠链
LBP882M SIDEFLEXING CHAINS FOR MAGNETIC SYSTEM HEAVY DUTY SINGLE HINGE
with low noise accumulation rollers

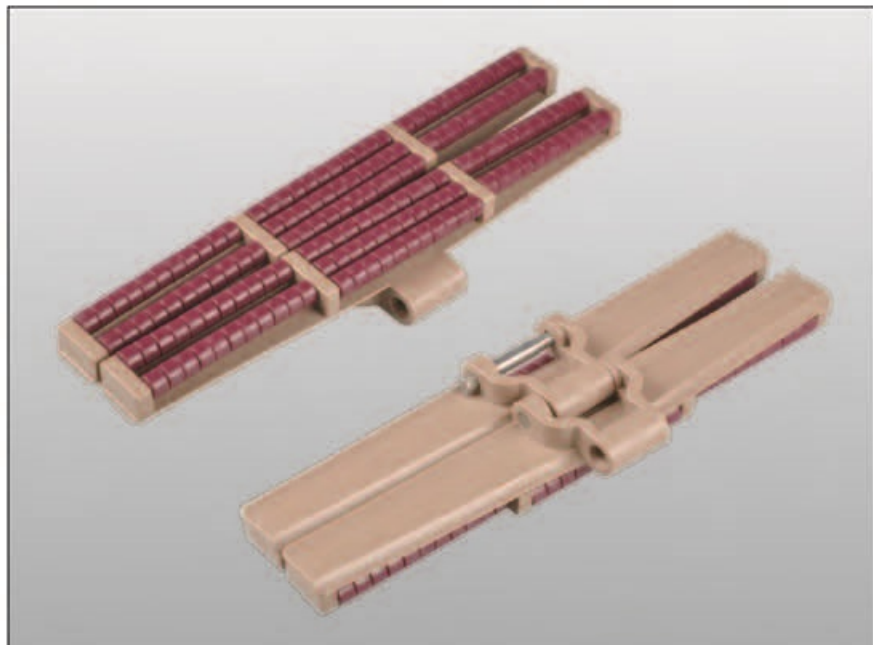

链号 Chain No.	宽度 Width (W)		重量 Weight kg/m
	mm	inch	
LBP882M - K750	190.5	7.5	4.2
LBP882M - K1000	254.0	10	5.2
LBP882M - K1200	304.8	12	5.8

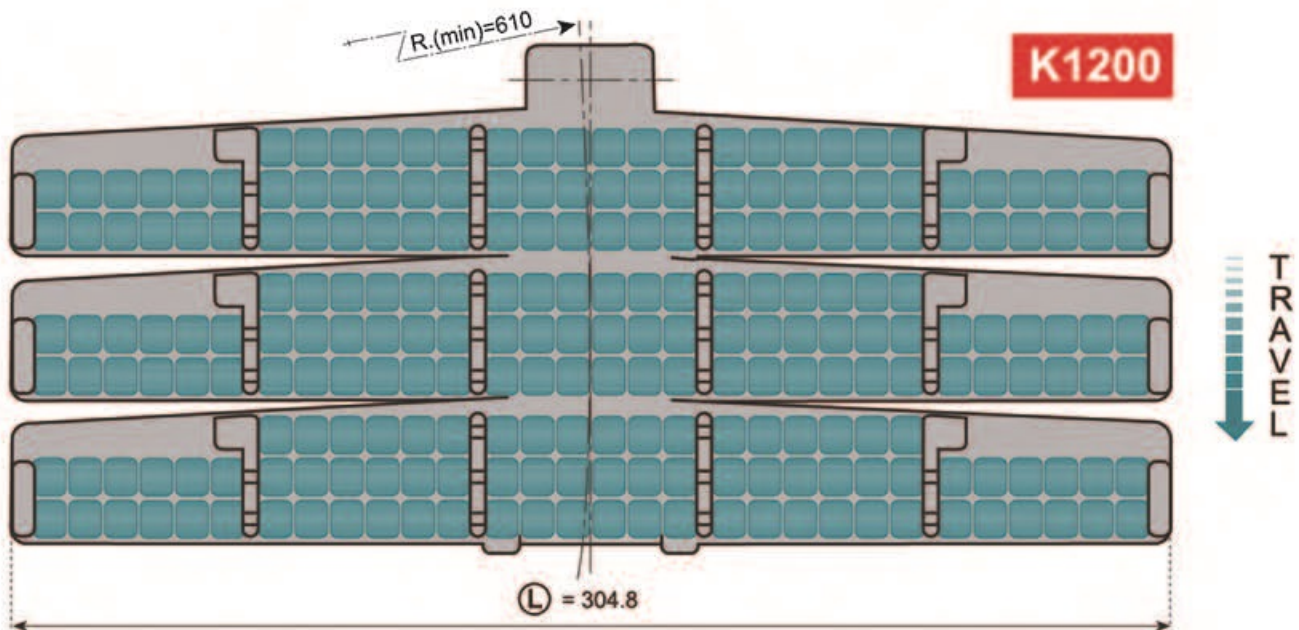
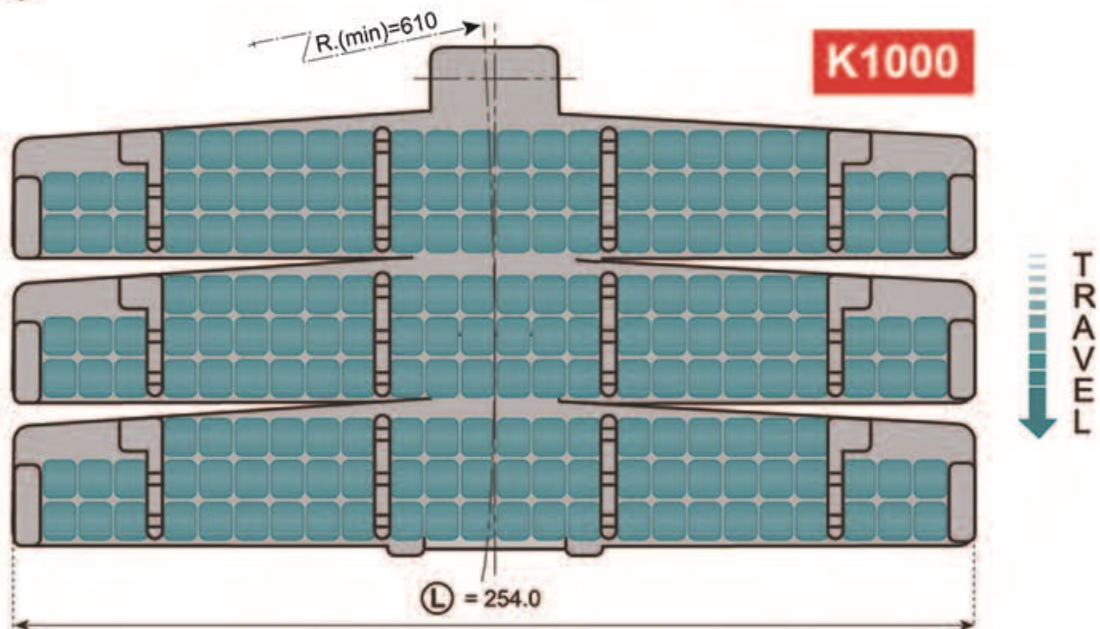
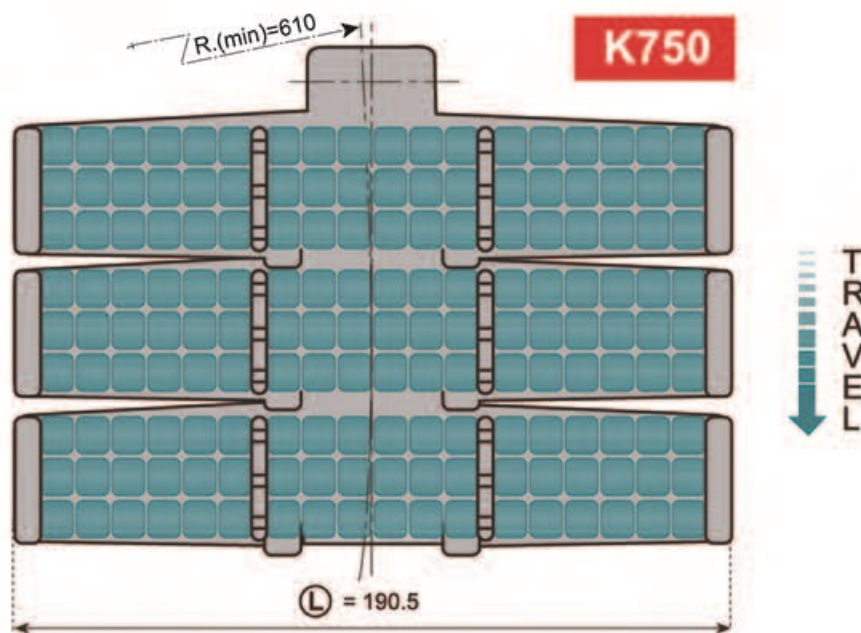
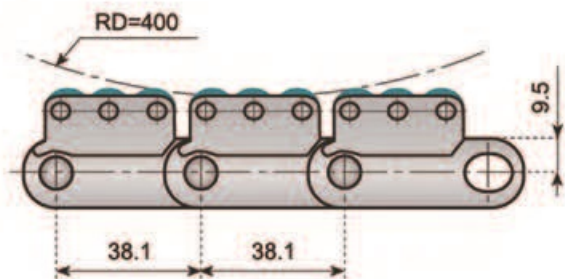
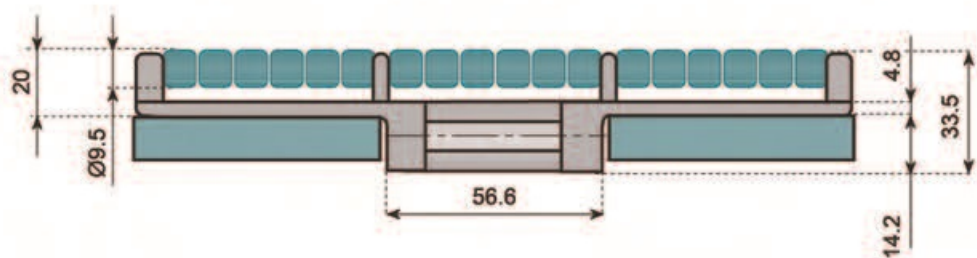

- 主要适用于各种食品，饮料，保特瓶，铝罐等收缩膜或纸箱包装线输送。
- 最大输送长度为12米。
- 工作载荷：2750N
- 轴心材质：不锈钢
- 链板及滚珠材质：POM 塑钢（使用温度：-40~90℃）
- 包装：10英尺 = 3.048 米/盒
1米=26片
- Mainly used for all kinds of food industry, such as beverage, bottle, can and other conveyors wrap packing.
- The longest distance: 12M
- Working load: 2750N
- Pin material: austenitic stainless steel
- Plate and rollers material: POM acetal (Temperature: -40 ~ 90°C)
- Packing: 10 feet = 3.048 M/box 26pcs/M

塑料平顶链(顶部带防滑胶) *Plastic Flat Top Chains With Rubber Top*

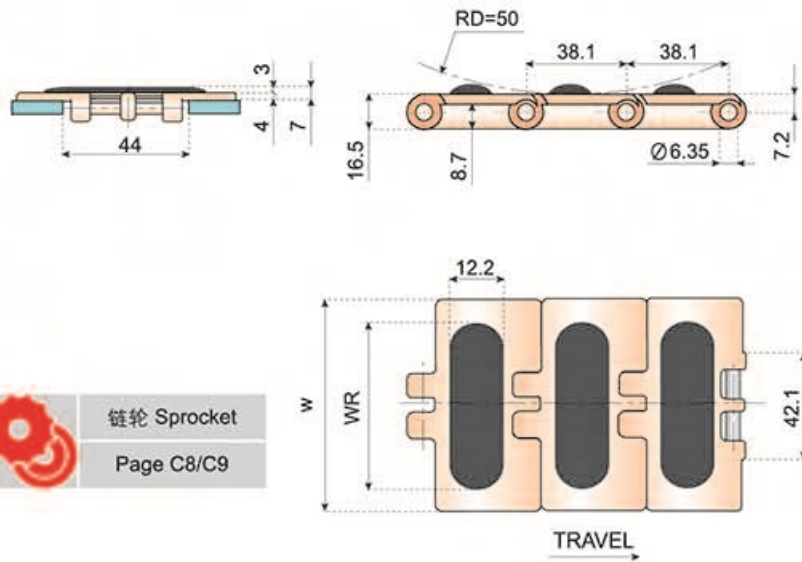

链轮 Sprocket
Page C8/C9

820G 防滑单铰直输平顶链 820G WITH RUBBER TOP

链号 Chain No.	链板宽度 Width (W)		橡胶宽度 Width (WR)	
	mm	inch	mm	inch
820 - K325G	82.6	3.25	63	2.48
820 - K350G	88.9	3.50	63	2.48
820 - K400G	101.6	4.00	63	2.48
820 - K450G	114.3	4.50	63	2.48
820 - K600G	152.4	6.00	130	5.12
820 - K750G	190.5	7.50	168	6.62

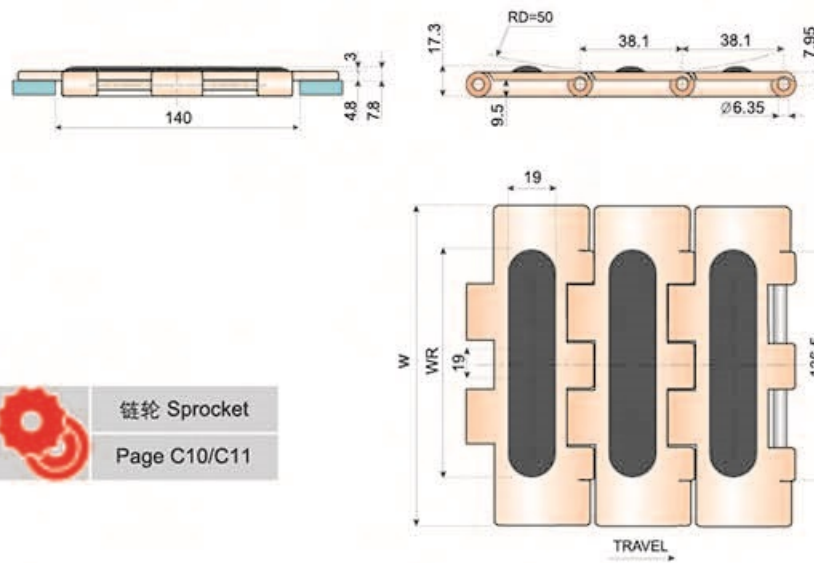
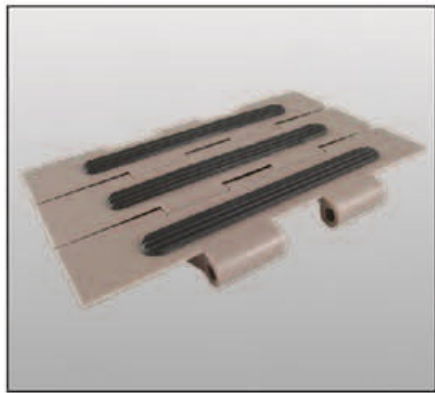

链轮 Sprocket
Page C10/C11

821G 防滑双铰直输平顶链 821G WITH RUBBER TOP

链号 Chain No.	链板宽度 Width (W)		橡胶宽度 Width (WR)	
	mm	inch	mm	inch
821 - K750G	190.5	7.50	168	6.62
821 - K1000G	254.0	10.00	195	7.68
821 - K1200G	304.8	12.00	245	9.65

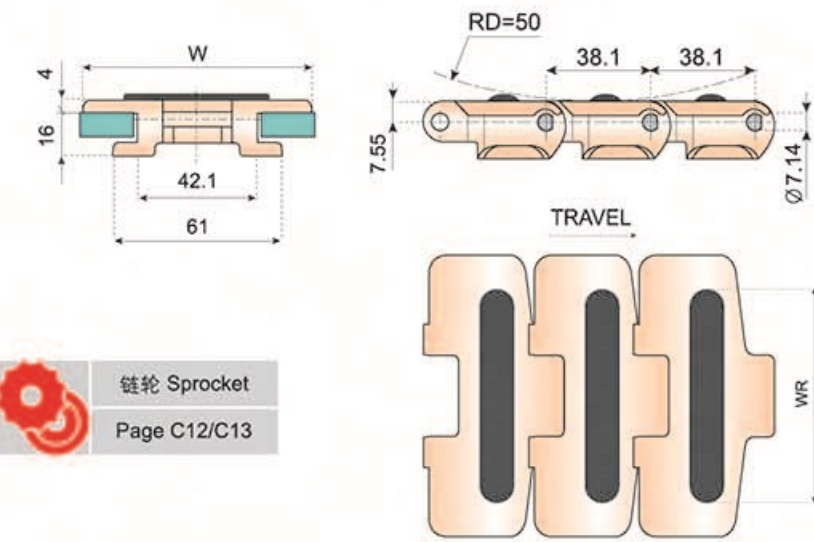
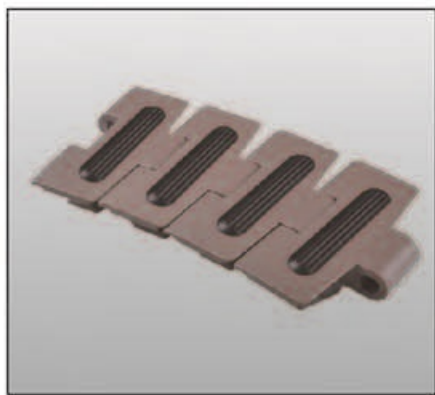

链轮 Sprocket
Page C12/C13

880TAB 防滑转弯链板 880TAB WITH RUBBER TOP

链号 Chain No.	链板宽度 Width (W)		橡胶宽度 Width (WR)	
	mm	inch	mm	inch
880TAB - K325G	82.6	3.25	63	2.48
880TAB - K450G	114.3	4.50	63	2.48

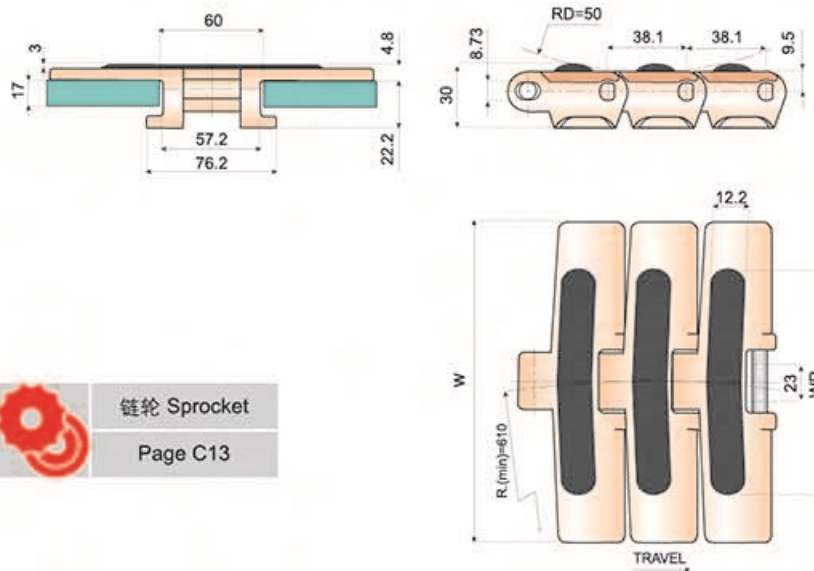
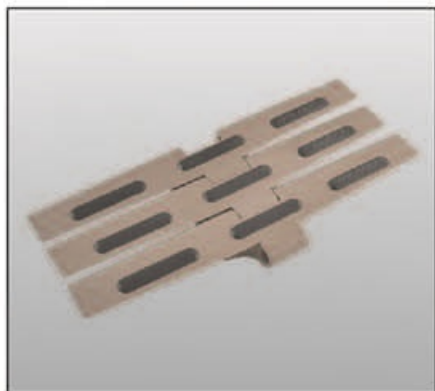

链轮 Sprocket
Page C13

882TAB-G 防滑侧弯平顶链 882TAB-G WITH RUBBER TOP

链号 Chain No.	链板宽度 Width (W)		橡胶宽度 Width (WR)	
	mm	inch	mm	inch
882TAB - K600G	152.4	6.00	130	5.12
882TAB - K750G	190.5	7.50	168	6.62
882TAB - K1000G	254	10.00	195	7.68
882TAB - K1200G	304.8	12.00	245	9.65

扣链式夹持输送链 Plastic Conveyor Chains With Snap On Gripper

1873GD 扣链式夹持输送链 1873GD SIDEFLEXING WITH SNAP ON GRIPPER

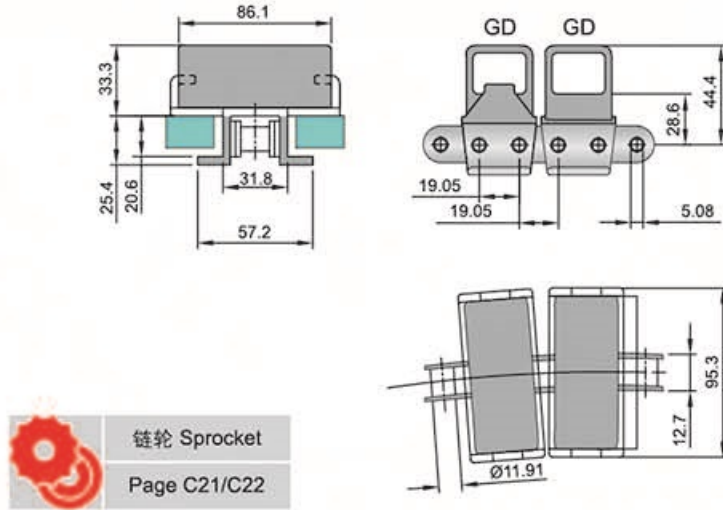
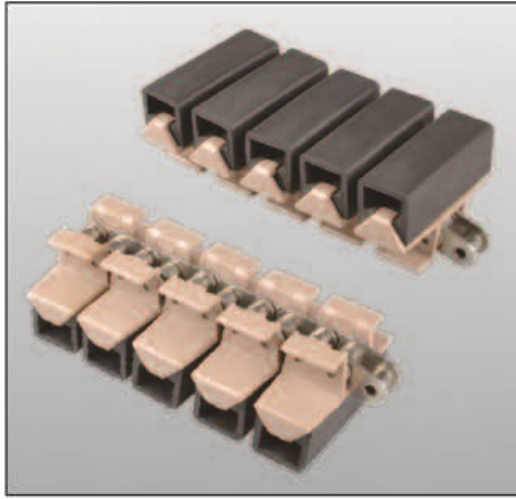

链号 Chain No.	宽度 Width (W)		重量 Weight	
	mm	inch	kg/m	lbs/ft
1873GD - K375	95.3	3.75	2.80	1.88

- 主要应用在各种夹瓶及夹罐爬升的输送。
底链分为不锈钢和碳钢两种材质。
- 最大输送长度为24米。
- 最高速度：润滑剂 90米/分钟
干燥 60米/分钟
- 包装：10英尺 = 3.048 米/盒
1米=26片
- Widely used in clip bottle and lift transportation.
- Material (base roller chain):
stainless steel SUS304 or carbon steel
- The longest distance: 24M
- Max. speed: lubricant 90M/min
dryness 60M/min
- Packing: 10 feet = 3.048 M/box 26pcs/M

1873GJ3A 扣链式夹持输送链 1873GJ3A SIDEFLEXING WITH SNAP ON GRIPPER

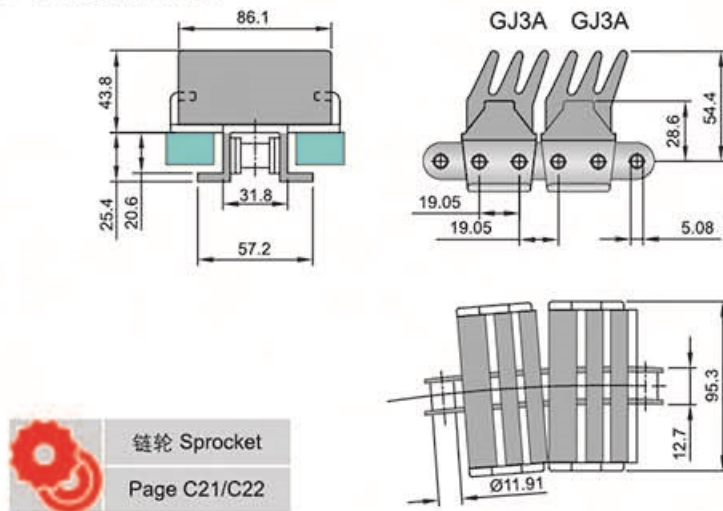
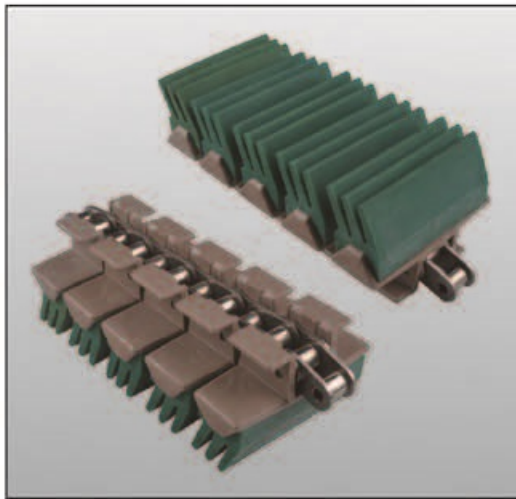

链号 Chain No.	宽度 Width (W)		重量 Weight	
	mm	inch	kg/m	lbs/ft
1873GJ3A - K375	95.3	3.75	2.90	1.90

- 主要应用在各种夹瓶及夹罐爬升的输送。
底链分为不锈钢和碳钢两种材质。
- 最大输送长度为24米。
- 最高速度：润滑剂 90米/分钟
干燥 60米/分钟
- 包装：10英尺 = 3.048 米/盒
1米=26片
- Widely used in clip bottle and lift transportation.
- Material (base roller chain):
stainless steel SUS304 or carbon steel
- The longest distance: 24M
- Max. speed: lubricant 90M/min
dryness 60M/min
- Packing: 10 feet = 3.048 M/box 26pcs/M

1873GJ3B 扣链式夹持输送链 1873GJ3B SIDEFLEXING WITH SNAP ON GRIPPER

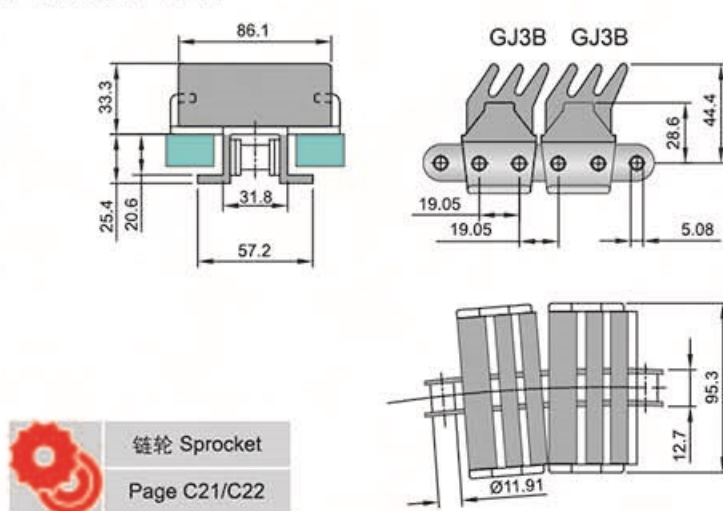
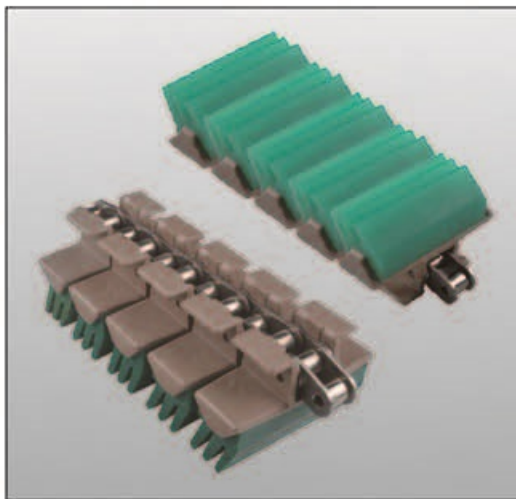

链号 Chain No.	宽度 Width (W)		重量 Weight	
	mm	inch	kg/m	lbs/ft
1873GJ3B - K375	95.3	3.75	2.80	1.88

- 主要应用在各种夹瓶及夹罐爬升的输送。
底链分为不锈钢和碳钢两种材质。
- 最大输送长度为24米。
- 最高速度：润滑剂 90米/分钟
干燥 60米/分钟
- 包装：10英尺 = 3.048 米/盒
1米=26片
- Widely used in clip bottle and lift transportation.
- Material (base roller chain):
stainless steel SUS304 or carbon steel
- The longest distance: 24M
- Max. speed: lubricant 90M/min
dryness 60M/min
- Packing: 10 feet = 3.048 M/box 26pcs/M

扣链式夹持输送链 Plastic Conveyor Chains With Snap On Gripper

1873GJ4 扣链式夹持输送链 1873GJ4 SIDEFLEXING WITH SNAP ON GRIPPER

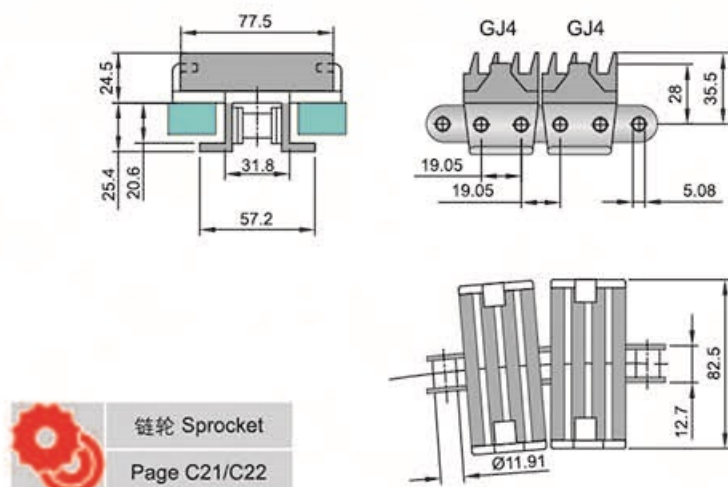
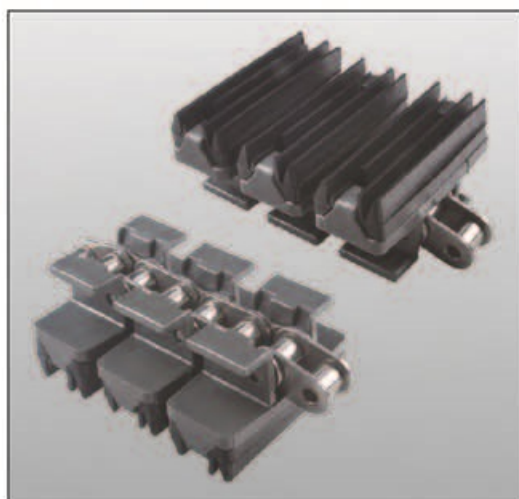

链号 Chain No.	宽度 Width (W)		重量 Weight	
	mm	inch	kg/m	lbs/ft
1873GJ4 - K325	82.5	3.25	2.80	1.88

- 主要应用在各种夹瓶及夹罐爬升的输送。
- 底链分为不锈钢和碳钢两种材质。
- 最大输送长度为24米。
- 最高速度：润滑剂 90米/分钟
干燥 60米/分钟
- 包装：10英尺 = 3.048 米/盒
1米=26片
- Widely used in clip bottle and lift transportation.
- Material (base roller chain):
stainless steel SUS304 or carbon steel
- The longest distance: 24M
- Max. speed: lubricant 90M/min
dryness 60M/min
- Packing: 10 feet = 3.048 M/box 26pcs/M

1873G4 扣链式夹持输送链 1873G4 SIDEFLEXING WITH SNAP ON GRIPPER

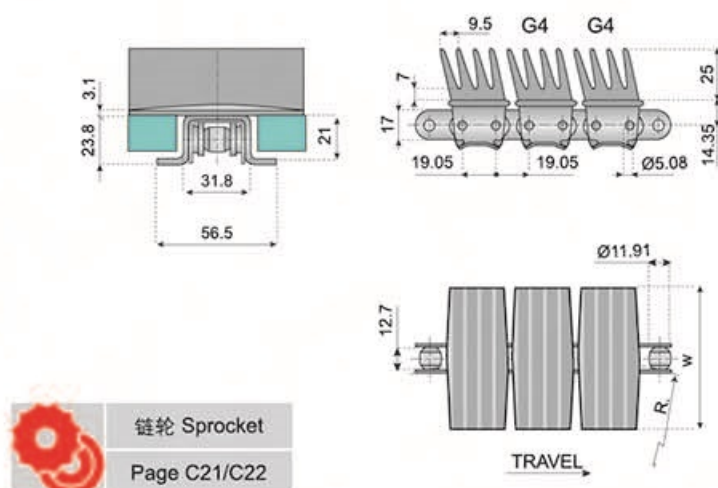
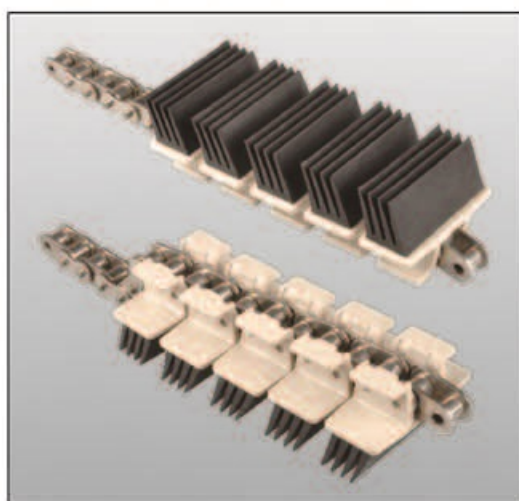

链号 Chain No.	宽度 Width (W)		重量 Weight	
	mm	inch	kg/m	lbs/ft
1873G4 - K325	82.6	3.25	3.00	2.02
1873G4 - K450	114.3	4.50	3.40	2.29

- 主要应用在各种夹瓶及夹罐爬升的输送。
- 底链分为不锈钢和碳钢两种材质。
- 最大输送长度为24米。
- 最高速度：润滑剂 90米/分钟
干燥 60米/分钟
- 包装：10英尺 = 3.048 米/盒
1米=26片
- Widely used in clip bottle and lift transportation.
- Material (base roller chain):
stainless steel SUS304 or carbon steel
- The longest distance: 24M
- Max. speed: lubricant 90M/min
dryness 60M/min
- Packing: 10 feet = 3.048 M/box 26pcs/M

1873G4M 扣链式提升链 1873G4M Sideflexing with Snap on Gripper

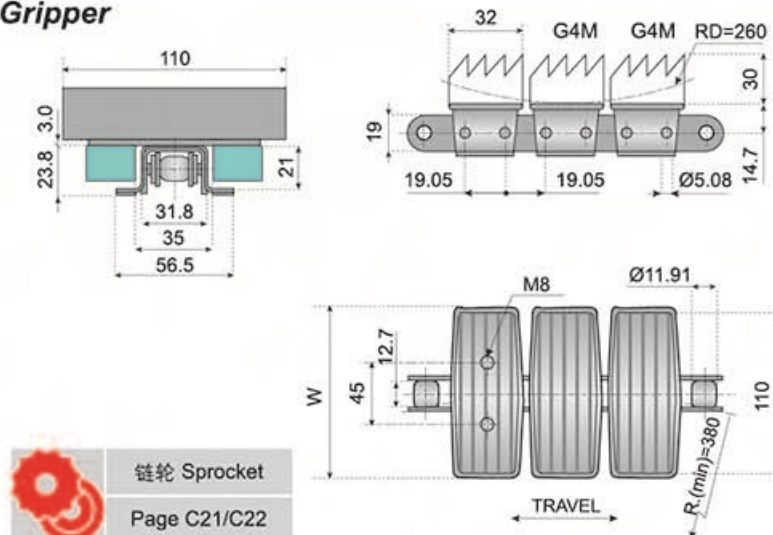

链号 Chain No.	宽度 Width (W)		重量 Weight	
	mm	inch	kg/m	lbs/ft
1873G4M - K325	82.6	3.25	5.20	3.70
1873G4M - K450	114.3	4.50	5.50	3.90
1873G4M - K600	152.4	6.00	5.70	4.05
1873G4M - K750	190.5	7.50	5.90	4.20

- 主要应用在各种夹瓶及夹罐爬升的输送。
- 底链分为不锈钢和碳钢两种材质。
- 最大输送长度为24米。
- 最高速度：润滑剂 90米/分钟
干燥 60米/分钟
- 包装：10英尺 = 3.048 米/盒
1米=26片
- Widely used in clip bottle and lift transportation.
- Material (base roller chain):
stainless steel SUS304 or carbon steel
- The longest distance: 24M
- Max. speed: lubricant 90M/min
dryness 60M/min
- Packing: 10 feet = 3.048 M/box 26pcs/M

扣链式夹持输送链 Plastic Conveyor Chains With Snap On Gripper

1873D1 扣链式夹持输送链 (丁晴橡胶) 1873D1 SIDEFLEXING WITH SNAP ON GRIPPER (NBR)

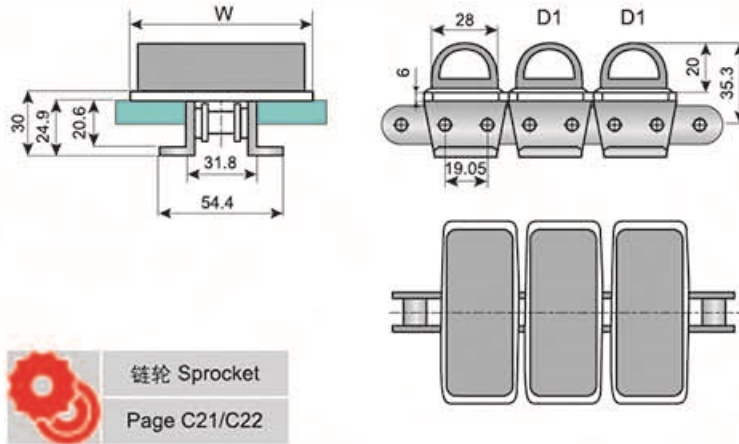
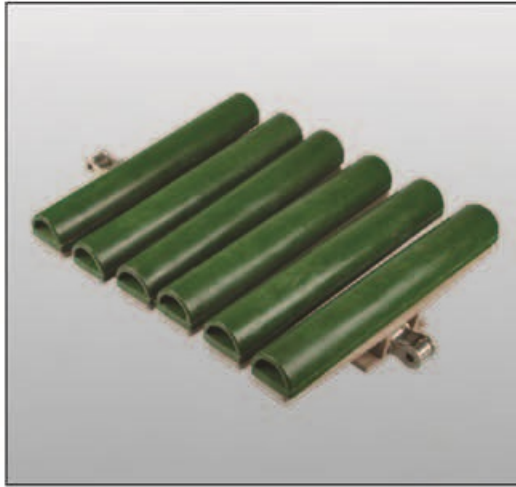

链轮 Sprocket
Page C21/C22

链号 Chain No.	宽度 Width (W)		重量 Weight	
	mm	inch	kg/m	lbs/ft
1873D1 - K325	82.6	3.25	2.9	1.95
1873D1 - K450	114.3	4.50	3.5	2.35
1873D1 - K600	152.4	6.00	4.1	2.76
1873D1 - K750	190.5	7.50	4.5	3.03

- 主要应用在各种夹瓶及夹罐爬升的输送。
底链分为不锈钢和碳钢两种材质。
- 最大输送长度为24米。
- 最高速度：润滑剂 90米/分钟
干燥 60米/分钟
- 包装：10英尺 = 3.048 米/盒
1米=26片
- Widely used in clip bottle and lift transportation.
- Material (base roller chain):
stainless steel SUS304 or carbon steel
- The longest distance: 24M
- Max. speed: lubricant 90M/min
dryness 60M/min
- Packing: 10 feet = 3.048 M/box 26pcs/M

1873D2 扣链式夹持输送链 (天然橡胶) 1873D2 SIDEFLEXING WITH SNAP ON GRIPPER (Nature Rubber)

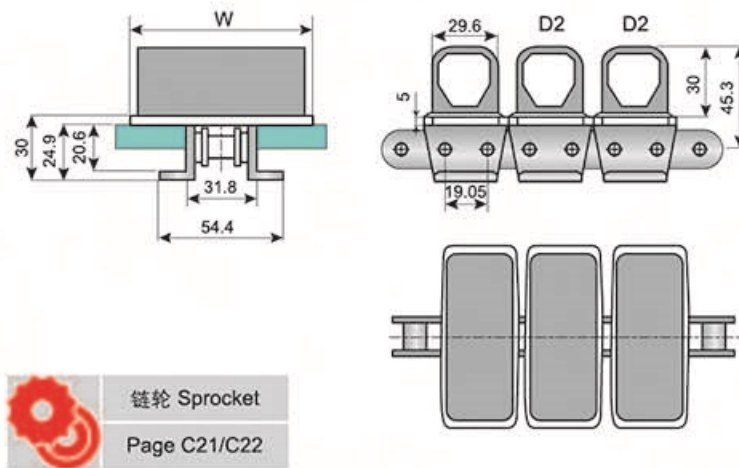
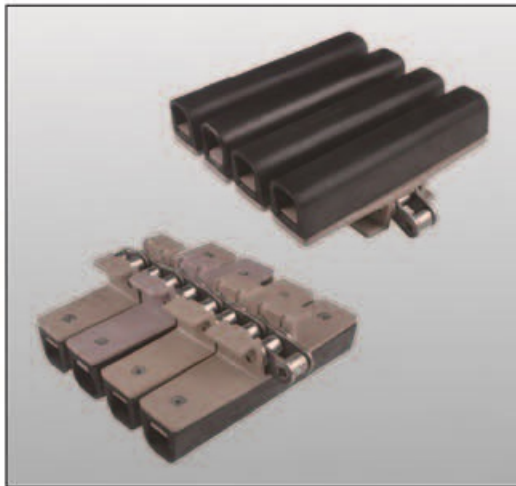

链轮 Sprocket
Page C21/C22

链号 Chain No.	宽度 Width (W)		重量 Weight	
	mm	inch	kg/m	lbs/ft
1873D2 - K325	82.6	3.25	2.9	1.95
1873D2 - K450	114.3	4.50	3.5	2.35
1873D2 - K600	152.4	6.00	4.1	2.76
1873D2 - K750	190.5	7.50	4.5	3.03

- 主要应用在各种夹瓶及夹罐爬升的输送。
底链分为不锈钢和碳钢两种材质。
- 最大输送长度为24米。
- 最高速度：润滑剂 90米/分钟
干燥 60米/分钟
- 包装：10英尺 = 3.048 米/盒
1米=26片
- Widely used in clip bottle and lift transportation.
- Material (base roller chain):
stainless steel SUS304 or carbon steel
- The longest distance: 24M
- Max. speed: lubricant 90M/min
dryness 60M/min
- Packing: 10 feet = 3.048 M/box 26pcs/M

1873D3 扣链式夹持输送链 (硅胶) 1873D3 SIDEFLEXING WITH SNAP ON GRIPPER (Silica Gel)

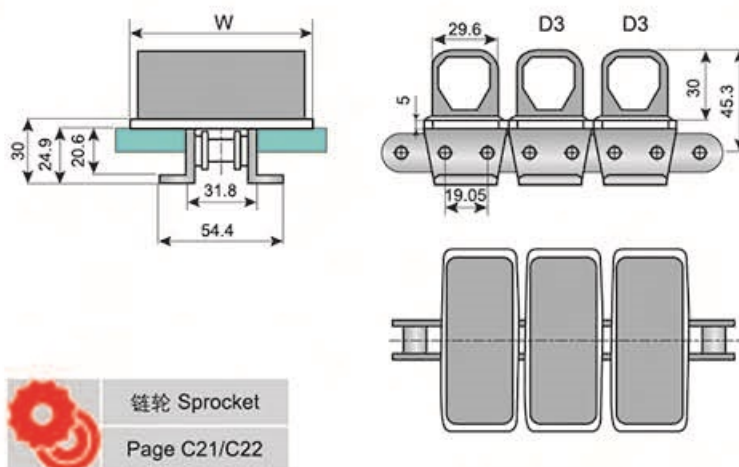

链轮 Sprocket
Page C21/C22

链号 Chain No.	宽度 Width (W)		重量 Weight	
	mm	inch	kg/m	lbs/ft
1873D3 - K325	82.6	3.25	2.9	1.95
1873D3 - K450	114.3	4.50	3.5	2.35
1873D3 - K600	152.4	6.00	4.1	2.76
1873D3 - K750	190.5	7.50	4.5	3.03

- 主要应用在各种夹瓶及夹罐爬升的输送。
底链分为不锈钢和碳钢两种材质。
- 最大输送长度为24米。
- 最高速度：润滑剂 90米/分钟
干燥 60米/分钟
- 包装：10英尺 = 3.048 米/盒
1米=26片
- Widely used in clip bottle and lift transportation.
- Material (base roller chain):
stainless steel SUS304 or carbon steel
- The longest distance: 24M
- Max. speed: lubricant 90M/min
dryness 60M/min
- Packing: 10 feet = 3.048 M/box 26pcs/M

扣链式转弯输送链 Plastic Conveyor Chains With Base Roller Chains

1873 扣链式转弯输送链 1873 SIDEFLEXING with base roller chains 19.05mm (3/4") pitch

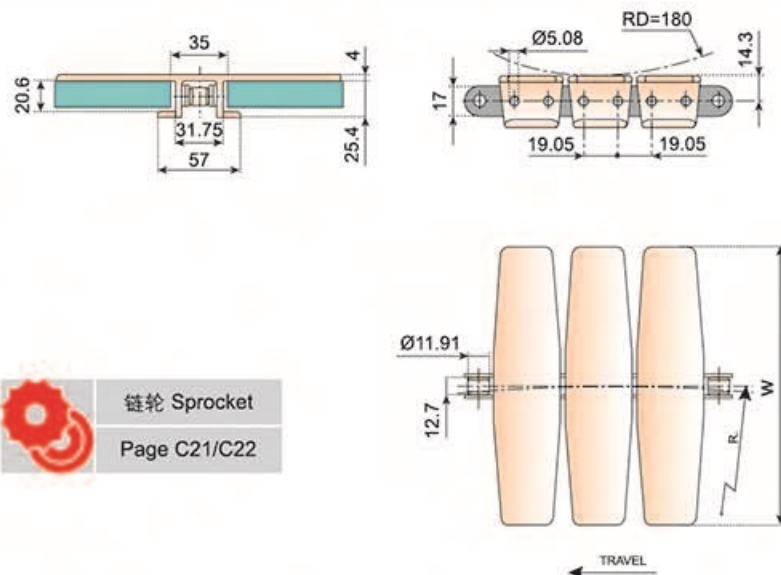

链轮 Sprocket
Page C21/C22

链号 Chain No.	宽度 Width (W)		重量 Weight		最小侧弯半径 Minimum Radius R min
	mm	inch	kg/m	lbs/ft	
LF1873 - K325	82.6	3.25	2.00	1.42	350
LF1873 - K450	114.3	4.50	2.30	1.55	350
LF1873 - K600	152.4	6.00	2.40	1.62	450
LF1873 - K750	190.5	7.50	2.60	1.75	500
LF1873 - K1000	254.0	10.00	2.80	1.88	500
LF1873 - K1200	304.8	12.00	3.00	2.02	610
LF1873 - K1600	406.4	16.00	3.45	2.65	610

- 主要应用在各种转弯输送之食品工业上。
- 底链分为不锈钢和碳钢两种材质。
- 最大输送长度为24米。
- 最高速度：润滑剂 90米/分钟
干燥 60米/分钟
- 包装：10英尺 = 3.048 米/盒
1米=26片
- Widely used in all kinds of curved transportation in food industry.
- Material (base roller chain) :
stainless steel SUS304 or carbon steel
- The longest distance: 24M
- Max. speed: lubricant 90M/min
dryness 60M/min
- Packing: 10 feet = 3.048 M/box 26pcs/M

1873G 防滑侧弯链 1873G WITH RUBBER TOP

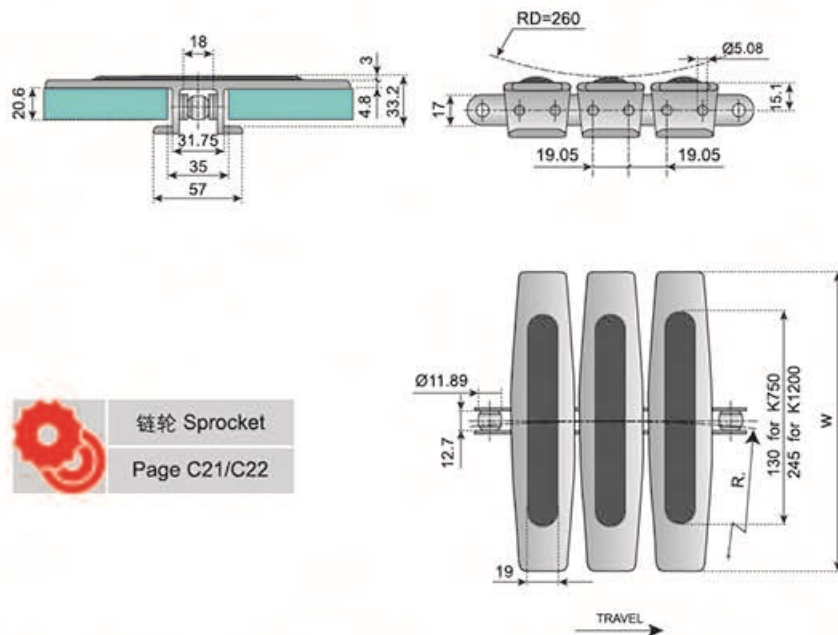
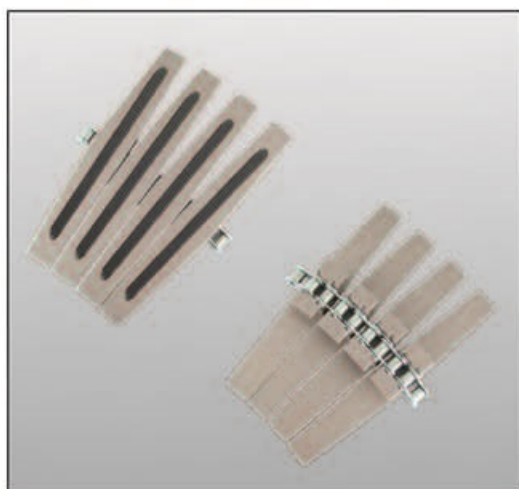

链轮 Sprocket
Page C21/C22

链号 Chain No.	宽度 Width (W)		重量 Weight		最小侧弯半径 Minimum Radius R min
	mm	inch	kg/m	lbs/ft	
LF1873 - K325G	82.6	3.25	2.20	1.69	350
LF1873 - K450G	114.3	4.50	2.33	1.79	350
LF1873 - K600G	152.4	6.00	2.60	2.00	450
LF1873 - K750G	190.5	7.50	2.80	2.16	500
LF1873 - K1000G	254.0	10.00	3.09	2.38	500
LF1873 - K1200G	304.8	12.00	3.34	2.57	610
LF1873 - K1600G	406.4	16.00	3.47	2.68	610

- 主要应用在各种转弯输送之食品工业上。
- 底链分为不锈钢和碳钢两种材质。
- 最大输送长度为24米。
- 最高速度：润滑剂 90米/分钟
干燥 60米/分钟
- 包装：10英尺 = 3.048 米/盒
1米=26片
- Widely used in all kinds of curved transportation in food industry.
- Material (base roller chain) :
stainless steel SUS304 or carbon steel
- The longest distance: 24M
- Max. speed: lubricant 90M/min
dryness 60M/min
- Packing: 10 feet = 3.048 M/box 26pcs/M

扣链式转弯输送链 Plastic Conveyor Chains With Base Roller Chains

1873G 防滑侧弯链 1873G WITH RUBBER TOP

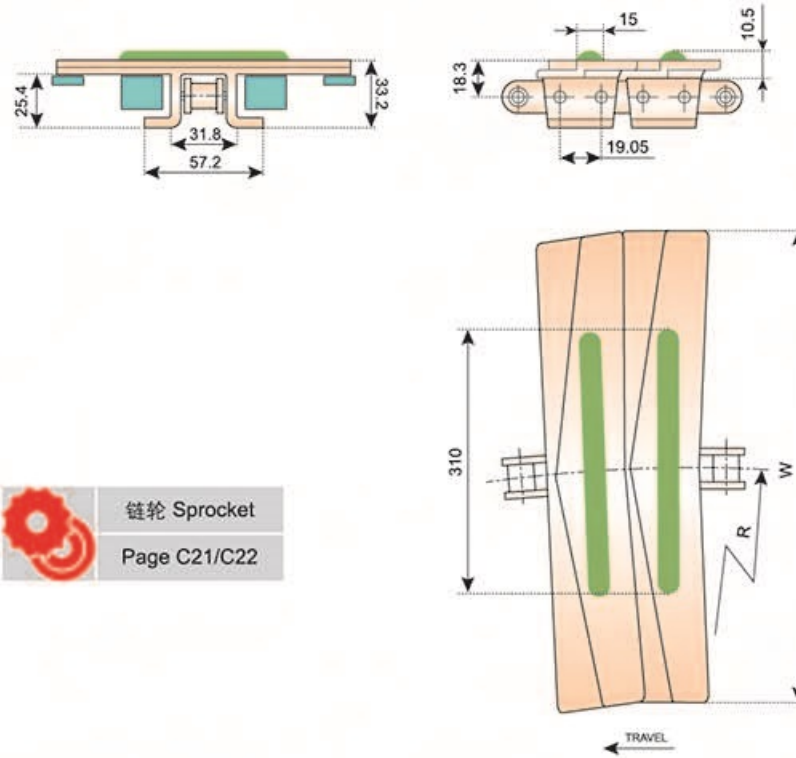
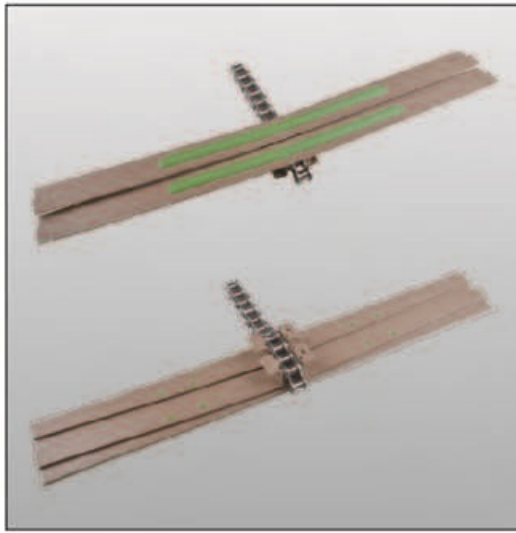

链轮 Sprocket
Page C21/C22

链号 Chain No.	宽度 Width (W)		重量 Weight		最小侧弯半径 Minimum Radius R min. (mm)
	mm	inch	kg/m	lbs/ft	
STEEL BASE ROLLER CHAIN					
LF1873 - K2400G	609.6	24.00	6.52	4.38	680
STAINLESS STEEL BASE ROLLER CHAIN					
LF1873SS - K2400G	609.6	24.00	6.52	4.38	680

- 适用于各种高速转弯输送，如食品工业，餐盘输送等长距离输送线的应用
- 底链分优质碳钢与不锈钢两种材质
- 链条设计是由底链扣住塑钢顶板片而成
- 最大输送长度：碳钢30米，不锈钢24米
- 最高速度：润滑剂 90米/分钟
干燥 60米/分钟
- 包装：10英尺 = 3.048 米/盒
1米=26片
- 最大负载拉力碳钢≤4000N
最大负载拉力不锈钢≤2000N
- Mainly used for high-speed long-distance curve conveyors, such as food industry, dish conveying.
- Bottom chain: carbon steel or stainless steel
- Consist of metal chain and plastic chain
- The longest distance: carbon steel - 30m
stainless steel - 24m
- Max. speed: lubricant 90M / min
dryness 60M / min
- Packing: 10 feet = 3.048 M / box 26pcs / M
- Max. tensile strength in carbon≤4000N
stainless steel≤2000N

1873SCS 扣链式链板(螺旋输送系统) 1873SCS CHAIN (SPIRAL CONVEYOR SYSTEM)

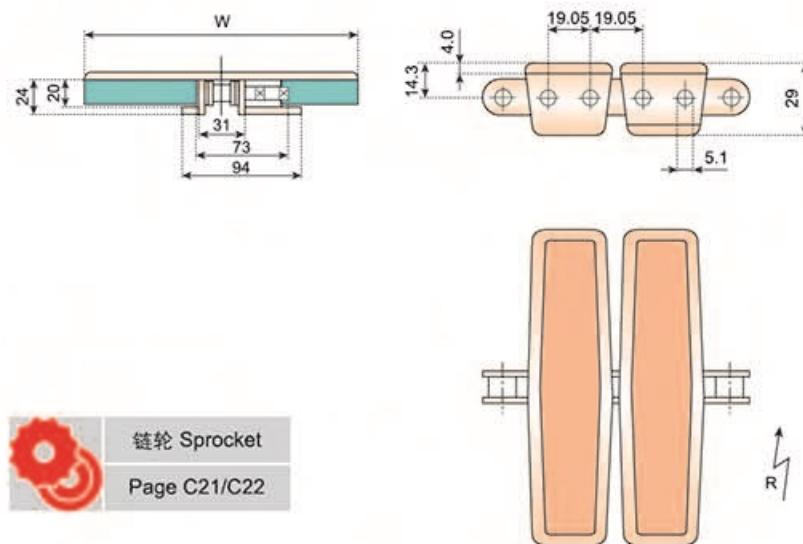

链轮 Sprocket
Page C21/C22

链号 Chain No.	宽度 Width (W)		重量 Weight		最小侧弯半径 Minimum Radius R min. (mm)
	mm	inch	kg/m	lbs/ft	
STEEL BASE ROLLER CHAIN					
LF1873SCS - K1200	304.8	12.00	3.61	2.78	450
LF1873SCS - K1600	406.4	16.00	4.05	3.12	610
LF1873SCS - K2400	609.6	24.00	4.75	3.66	680
STAINLESS STEEL BASE ROLLER CHAIN					
LF1873SS - SCS - K1200	304.8	12.00	3.61	2.78	450
LF1873SS - SCS - K1600	406.4	16.00	4.05	3.12	610
LF1873SS - SCS - K2400	609.6	24.00	4.75	3.66	680

- 适用于各种高速转弯输送，如食品工业，餐盘输送等长距离输送线的应用
- 底链分优质碳钢与不锈钢两种材质
- 链条设计是由底链扣住塑钢顶板片而成
- 最大输送长度：碳钢30米，不锈钢24米
- 最高速度：润滑剂 90米/分钟
干燥 60米/分钟
- 包装：10英尺 = 3.048 米/盒
1米=26片
- 最大负载拉力碳钢≤4000N
最大负载拉力不锈钢≤2000N
- Mainly used for high-speed long-distance curve conveyors, such as food industry, dish conveying.
- Bottom chain: carbon steel or stainless steel
- Consist of metal chain and plastic chain
- The longest distance: carbon steel - 30m
stainless steel - 24m
- Max. speed: lubricant 90M / min
dryness 60M / min
- Packing: 10 feet = 3.048 M / box 26pcs / M
- Max. tensile strength in carbon≤4000N
stainless steel≤2000N

扣链式转弯输送链 *Plastic Conveyor Chains With Base Roller Chains*

3873 扣链式转弯输送链

3873 *SIDEFLEXING CLOSED SURFACE with base roller chains 19.05mm (3/4") pitch*

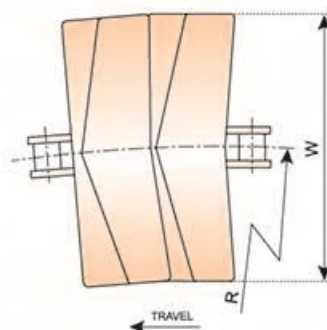
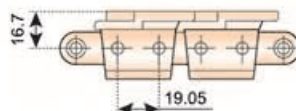
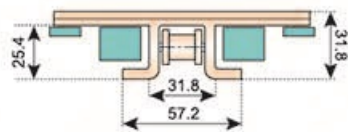

链号 Chain No.	宽度 Width (W)		重量 Weight		最小侧弯半径 Minimum Radius R min.
	mm	inch	kg/m	lbs/ft	
STEEL BASE ROLLER CHAIN					
LF3873 - K1000	254.0	10.00	3.24	2.50	450
LF3873 - K1200	304.8	12.00	3.75	2.90	450
LF3873 - K1600	406.4	16.00	5.00	3.36	450
STAINLESS STEEL BASE ROLLER CHAIN					
LF3873SS - K1000	254.0	10.00	3.24	2.50	450
LF3873SS - K1200	304.8	12.00	3.75	2.90	450
LF3873SS - K1600	406.4	16.00	5.00	3.36	450

• 主要应用在各种转弯输送之食品工业上。

底链分为不锈钢和碳钢两种材质。

• 最大输送长度为24米。

• 最高速度：润滑剂 90米/分钟

干燥 60米/分钟

• 包装：10英尺 = 3.048 米/盒

1米=26片

• Widely used in all kinds of curved transportation in food industry.

• Material (base roller chain):

stainless steel SUS304 and carbon steel

• The longest distance: 24M

• Max. speed: lubricant 90M / min

dryness 60M / min

• Packing: 10 feet = 3.048 M / box 26pcs / M

3873G 扣链式带胶转弯输送链

3873G *SIDEFLEXING WITH RUBBER TOP*

with base roller chains 19.05mm (3/4") pitch

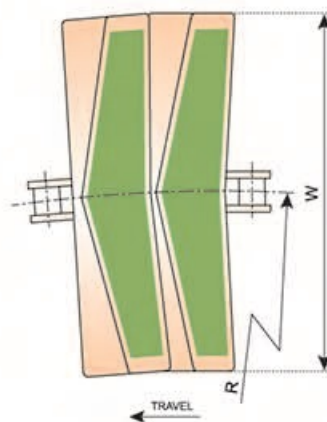
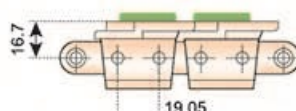
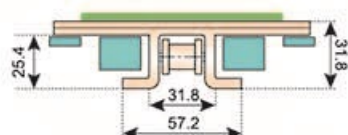
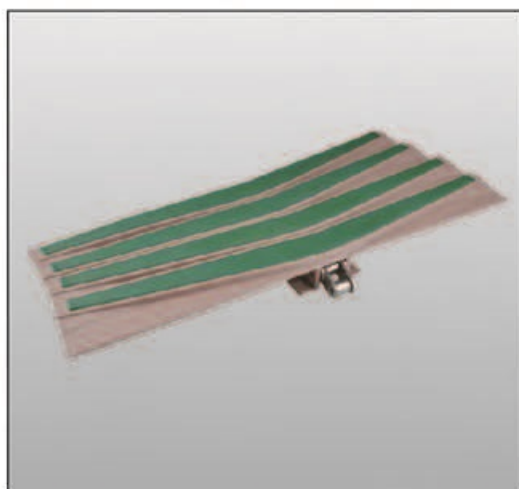

链号 Chain No.	宽度 Width (W)		重量 Weight		最小侧弯半径 Minimum Radius R min.
	mm	inch	kg/m	lbs/ft	
STEEL BASE ROLLER CHAIN					
LF3873 - K1000G	254.0	10.00	3.60	2.47	450
LF3873 - K1200G	304.8	12.00	3.95	2.66	450
LF3873 - K1600G	406.4	16.00	5.30	3.58	450
STAINLESS STEEL BASE ROLLER CHAIN					
LF3873SS - K1000G	254.0	10.00	3.60	2.47	450
LF3873SS - K1200G	304.8	12.00	3.95	2.66	450
LF3873SS - K1600G	406.4	16.00	5.30	3.58	450

• 主要应用在各种转弯输送之食品工业上。

底链分为不锈钢和碳钢两种材质。

• 最大输送长度为24米。

• 最高速度：润滑剂 90米/分钟

干燥 60米/分钟

• 包装：10英尺 = 3.048 米/盒

1米=26片

• Widely used in all kinds of curved transportation in food industry.

• Material (base roller chain):

stainless steel SUS304 and carbon steel

• The longest distance: 24M

• Max. speed: lubricant 90M / min

dryness 60M / min

• Packing: 10 feet = 3.048 M / box 26pcs / M

扣链式转弯输送链 Plastic Conveyor Chains With Base Roller Chains

3873-L 无间隙左转弯输送链板 3873-L SIDEFLEXING CHAIN

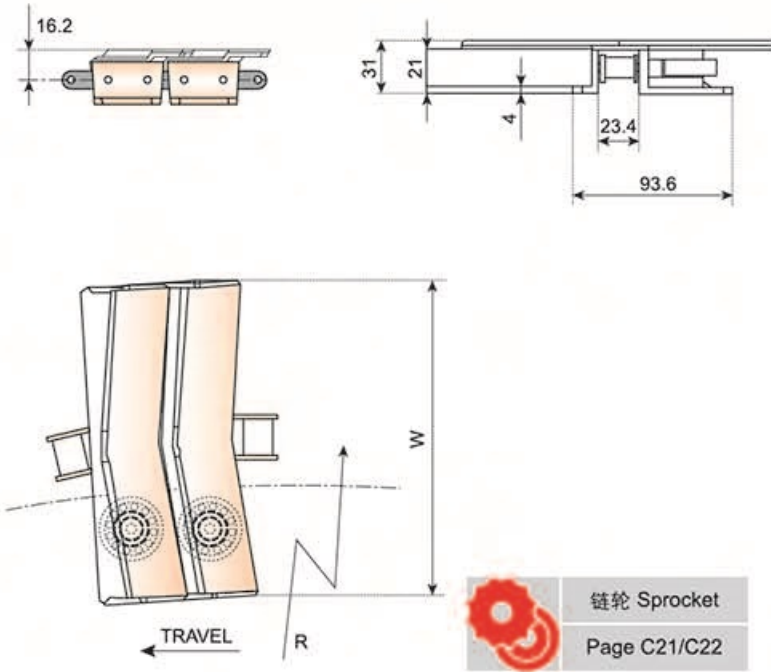
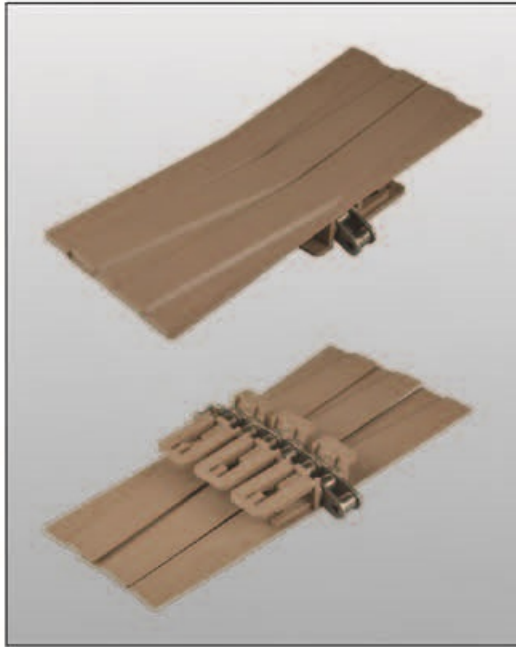

- 适合应用在各种高速转弯输送之食品工业，餐盘输送长距离输送线的应用
- 底链分优质碳钢与不锈钢两种材质
- 链条设计是由底链扣住塑钢顶板片而成
- 最大输送长度：碳钢30米，不锈钢24米
- 最高速度：润滑剂 90米/分钟
干燥 60米/分钟
- 包装：10英尺 = 3.048 米/盒
1米=26片
- 最大负载拉力碳钢≤4000N
最大负载拉力不锈钢≤2000N
- Application in high-speed curve conveyors in food industry dish conveying Long-distance conveying
- Bottom chain: carbon steel or stainless steel
- Consist of metal chain and plastic chain
- The longest distance: carbon steel-30m
stainless steel-24m
- Max. speed: lubricant 90M/min
dryness 60M/min
- Packing: 10 feet = 3.048 M/box 26pcs/M
- Max tensile force in carbon≤4000N
stainless steel≤2000N

链号 Chain No.	宽度 Width (W)		重量 Weight		最小侧弯半径 Minimum Radius R min
	mm	inch	kg/m	lbs/ft	
STEEL BASE ROLLER CHAIN					
3873 - L - K1000	254	10.00	4.52	1.78	450
3873 - L - K1200	304.8	12.00	4.81	1.89	450
STAINLESS STEEL BASE ROLLER CHAIN					
3873SS - L - K1000	254	10.00	4.52	1.78	450
3873SS - L - K1200	304.8	12.00	4.81	1.89	450

3873-R 无间隙右转弯输送链板 3873-R SIDEFLEXING CHAIN

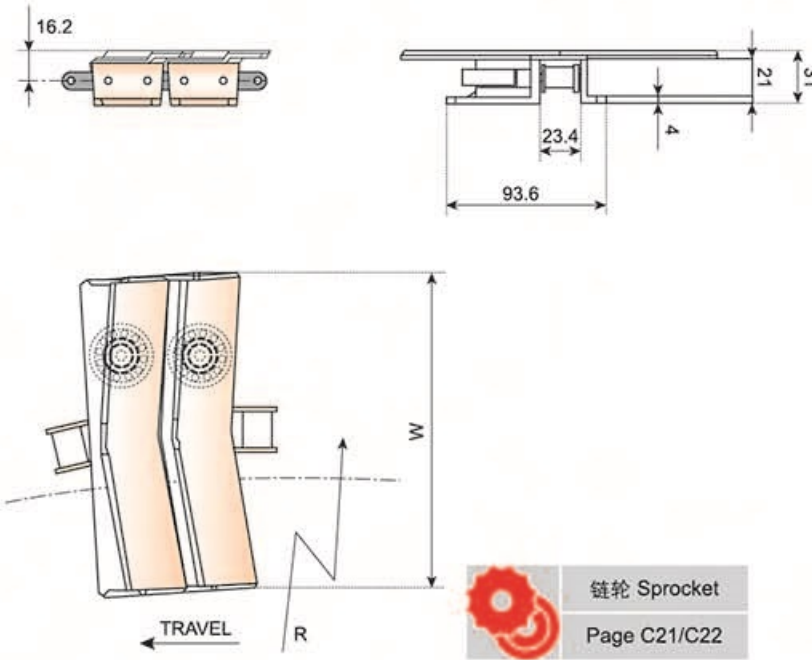

- 适合应用在各种高速转弯输送之食品工业，餐盘输送长距离输送线的应用
- 底链分优质碳钢与不锈钢两种材质
- 链条设计是由底链扣住塑钢顶板片而成
- 最大输送长度：碳钢30米，不锈钢24米
- 最高速度：润滑剂 90米/分钟
干燥 60米/分钟
- 包装：10英尺 = 3.048 米/盒
1米=26片
- 最大负载拉力碳钢≤4000N
最大负载拉力不锈钢≤2000N
- Application in high-speed curve conveyors in food industry dish conveying Long-distance conveying
- Bottom chain: carbon steel or stainless steel
- Consist of metal chain and plastic chain
- The longest distance: carbon steel-30m
stainless steel-24m
- Max. speed: lubricant 90M/min
dryness 60M/min
- Packing: 10 feet = 3.048 M/box 26pcs/M
- Max tensile force in carbon≤4000N
stainless steel≤2000N

链号 Chain No.	宽度 Width (W)		重量 Weight		最小侧弯半径 Minimum Radius R min
	mm	inch	kg/m	lbs/ft	
STEEL BASE ROLLER CHAIN					
3873 - R - K1000	254	10.00	4.52	1.78	450
3873 - R - K1200	304.8	12.00	4.81	1.89	450
STAINLESS STEEL BASE ROLLER CHAIN					
3873SS - R - K1000	254	10.00	4.52	1.78	450
3873SS - R - K1200	304.8	12.00	4.81	1.89	450

扣链式输送链 Plastic Conveyor Chains With Base Roller Chains

863 (963) 扣链式直行输送链

863 (963) STRAIGHT RUNNING PLASTIC CHAINS with base roller chains 19.05mm(3/4")pitch

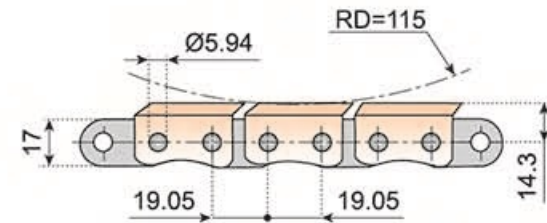
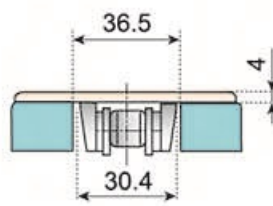
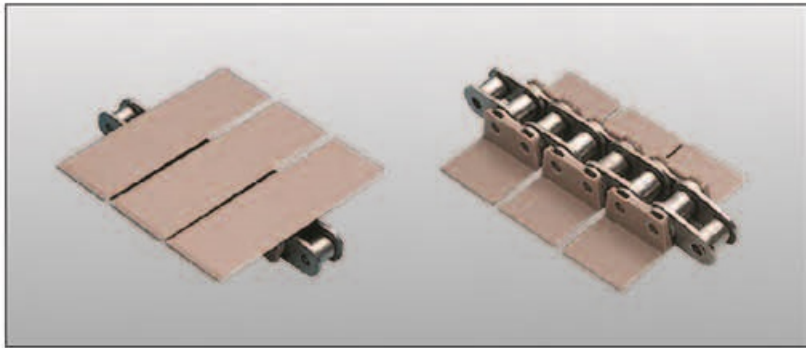

链号 Chain No.	宽度 Width (W)	
	mm	inch.
LF863(963) - K325	82.5	3.25
LF863(963) - K450	114.3	4.50
LF863(963) - K600	152.4	6.00
LF863(963) - K750	190.5	7.50

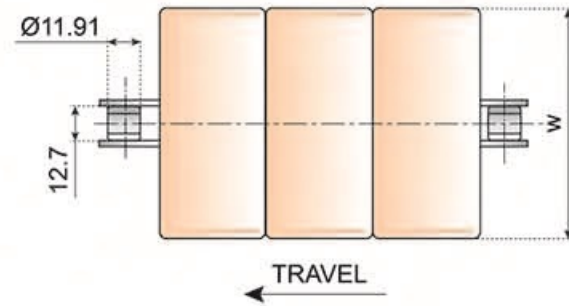

963 链条配转弯基链
963 with Side Bow Base Chain

843 扣链式直行输送链

843 STRAIGHT RUNNING PLASTIC CHAINS with base roller chains 12.7mm(1/2")pitch

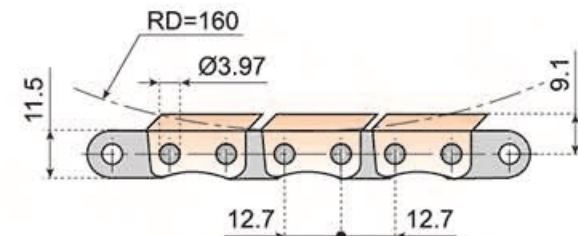
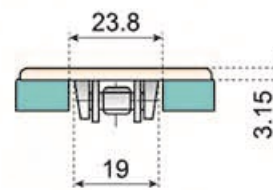
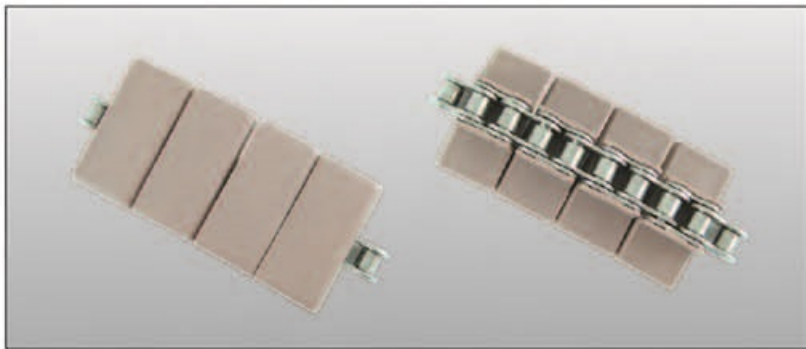

链号 Chain No.	宽度 Width (W)	
	mm	inch.
LF843 - K118	28.6	1.18
LF843 - K200	50.8	2.00
LF843 - K325	82.6	3.25

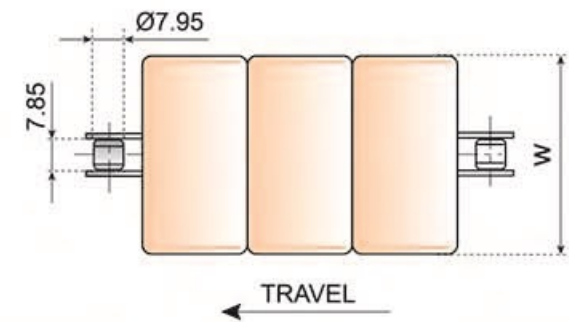

845 扣链式直行输送链

845 STRAIGHT RUNNING PLASTIC CHAINS with base roller chains 12.7mm(1/2")pitch

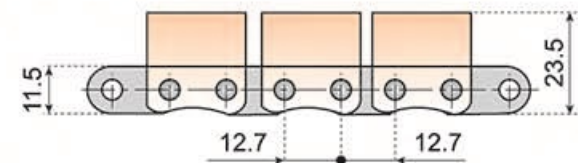
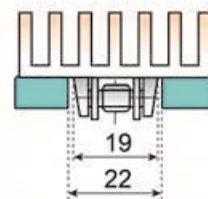
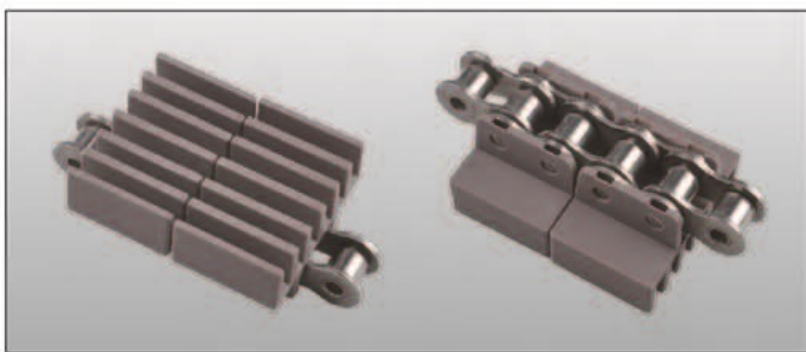

链号 Chain No.	宽度 Width (W)	
	mm	inch.
LF845 - K110	27.94	1.10
LF845 - K137	34.80	1.37
LF845 - K150	38.10	1.50
LF845 - K160	40.64	1.60
LF845 - K200	50.80	2.00

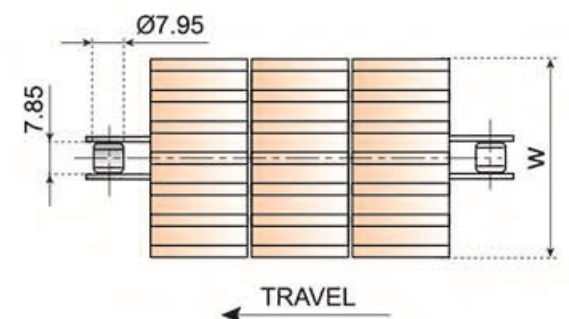

扣链式输送链 Plastic Conveyor Chains With Base Roller Chains

1843 扣链式转弯输送链
1843 SIDEFLEXING PLASTIC CHAINS with base roller chains 12.7mm(1/2")pitch

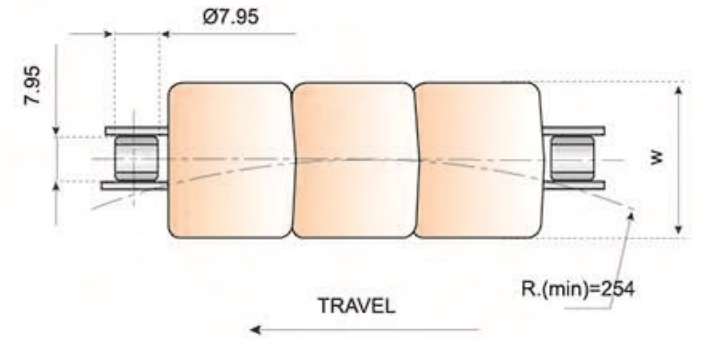
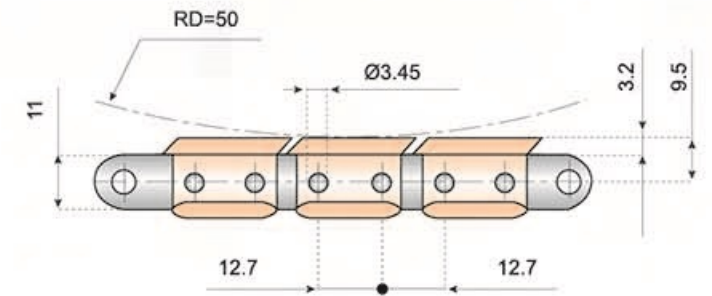
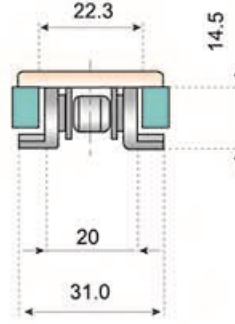
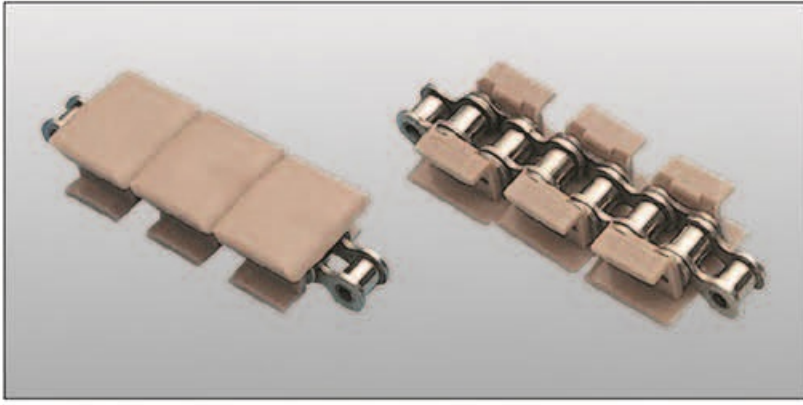

链号 Chain No.	宽度 Width (W)	
	mm	inch.
LF1843 - K125	31.8	1.25
LF1843 - K200	50.8	2



1843G3 扣链式转弯输送链
1843G3 SIDEFLEXING PLASTIC CHAINS with base roller chains 12.7mm(1/2")pitch

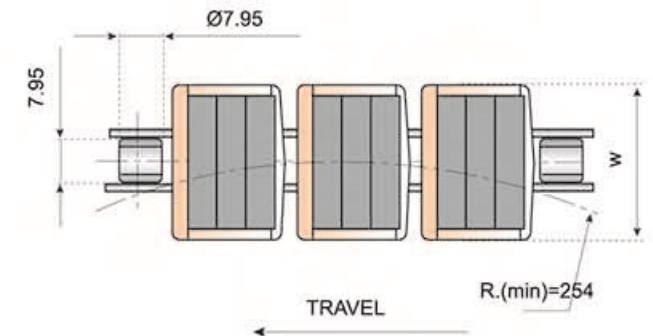
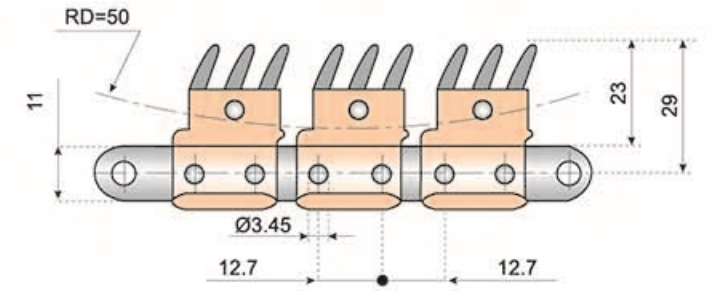
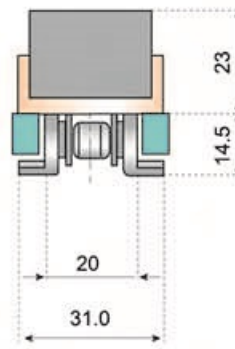
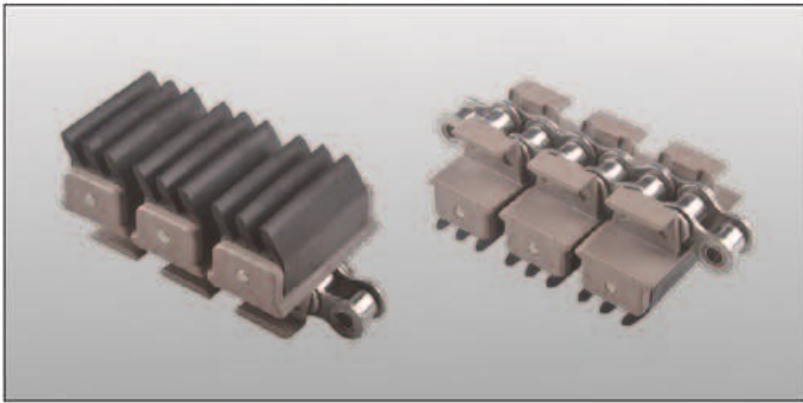

链号 Chain No.	宽度 Width (W)	
	mm	inch.
1843G3 - K178	45.22	1.78



配套基链 *Base Roller Chains*

1873 (963) 配套基链
1873 (963) Base Roller Chain 19.05mm (3/4") pitch

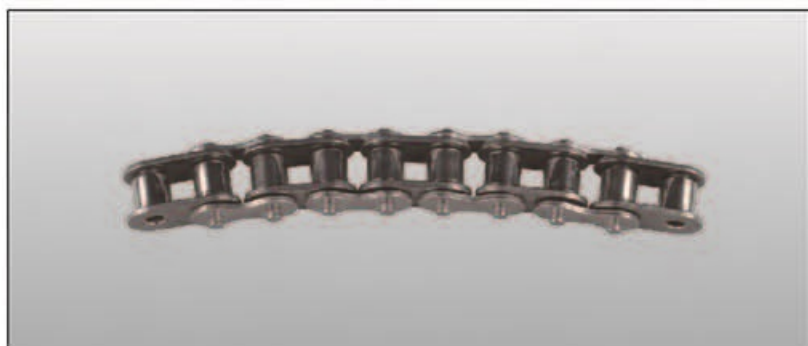

材质: 不锈钢或碳钢
 Material: Stainless Steel or Carbon Steel

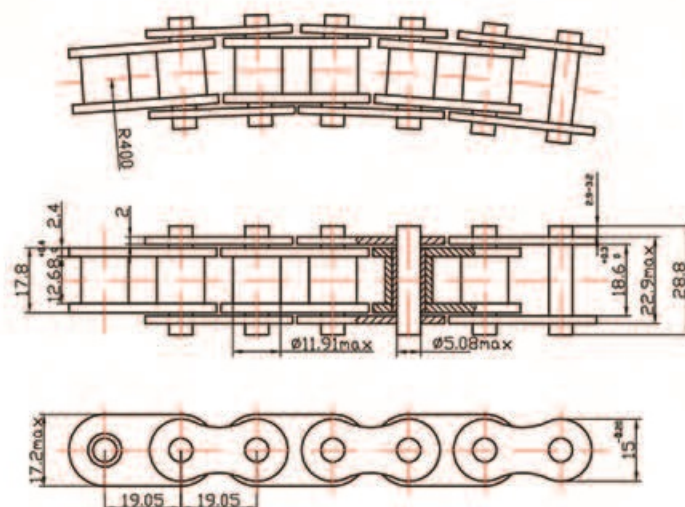

1843 配套基链
1843 Base Roller Chain 12.7mm (1/2") pitch



材质: 不锈钢或碳钢
 Material: Stainless Steel or Carbon Steel

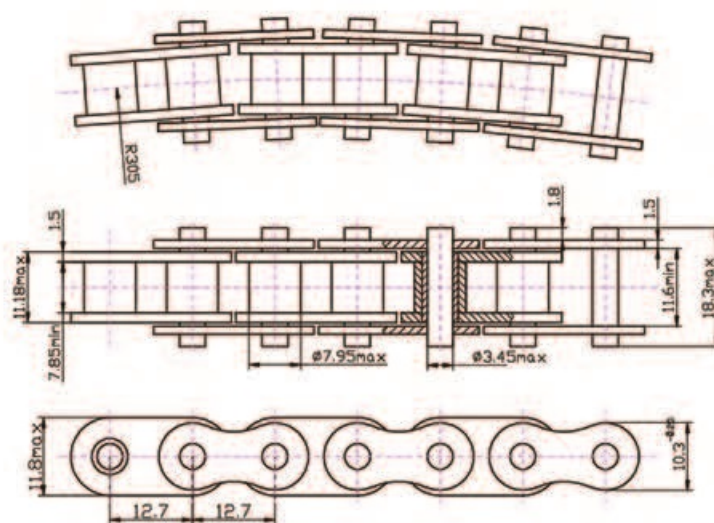

863 配套基链
863 Base Roller Chain 19.05mm (3/4") Pitch



材质: 不锈钢或碳钢
 Material: Stainless Steel or Carbon Steel

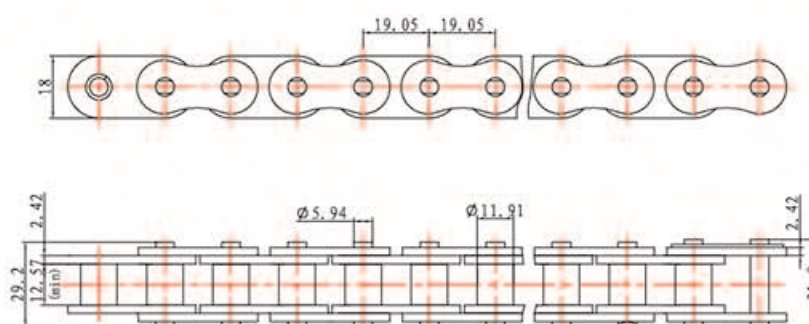

843 配套基链
843 Base Roller Chain 12.7mm (1/2") Pitch



材质: 不锈钢或碳钢
 Material: Stainless Steel or Carbon Steel

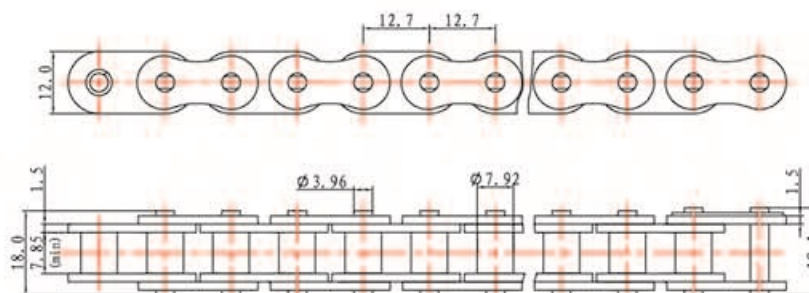

其它链条 *Other Chains*

